



belling

---

**INSIDE  
EVERY  
GREAT  
HOME**

---

User Manual



**Countries of destination:**

GB - Great Britain

IE - Ireland

DE - Germany

ES - Spain

FR - French

IT - Italy

PL - Poland

NL - Netherlands

SE - Sweden

CN - China

NZ - New Zealand

AU - Australia

To contact Belling about your appliance, please call:



**Customer Care Helpline**

**0344 815 3746**

in case of difficulty within the UK



**Warranty Registration**

**0800 952 1068**

\*Please call our Customer Care team for extended warranty



**Spares Store**

**0344 815 3745**



To register your appliance online:

**[www.belling.co.uk](http://www.belling.co.uk)**



To contact us by email:

**[gdhainfo@gdha.com](mailto:gdhainfo@gdha.com)**



To register your appliance by mail:

**Please complete the warranty card and return to the address supplied**



Alternatively general, spares and service information is available from our website at: **[www.belling.co.uk](http://www.belling.co.uk)**

Calls are charged at the basic rate, please check with your telephone service provider for exact charges

Your new appliance comes with our **12-month guarantee**, protecting you against electrical and mechanical breakdown. To register, please complete the registration form included, register online or by phone. For full terms & conditions of the manufacturer's guarantee, please refer to the website above. In addition, you may wish to purchase an extended warranty. A leaflet explaining how to do this is included with your appliance.

Our policy is one of constant development and improvement, therefore we cannot guarantee the strict accuracy of all of our illustrations and specifications. Changes may have been made subsequent to publishing.

Glen Dimplex Home Appliances, Stoney Lane, Prescott, Merseyside, L35 2XW

# INTRODUCTION

---

This user guide book is designed to help you through each step of owning your new product.

Please read it carefully before you start using your appliance, as we have endeavored to answer as many questions as possible, and provide you with as much support as we can.

General information, spares and service information is available from our website.

If you should find something missing from your product or have any questions that are not covered in this user guide, please contact us (see contact information inside the front cover).

## European Directives

As a producer and a supplier of cooking appliances we are committed to the protection of the environment and are in compliance with the WEEE directive. All our electric products are labelled accordingly with the crossed out wheeled bin symbol. This indicates, for disposal purposes at end of life, that these products must be taken to a recognized collection points, such as local authority sites/local recycling centres.



This appliance Complies with European Community Directives (CE) for household and similar electrical appliances and Gas appliances where applicable.

This appliance conforms to European Directive regarding Eco design requirements for energy-related products. Our policy is one of constant development and improvement, therefore we cannot guarantee the strict accuracy of all of our illustrations and specifications - changes may have been made subsequent to publishing.

## Disposal of Packaging Material

The packaging materials used with this appliance can be recycled. Please dispose of the packaging materials in the appropriate container at your local waste disposal facilities.

### **UK ONLY GAS WARNING:**

If you smell gas, Do not try to light any appliance. Do not touch any electrical switch.  
Call the Gas Emergency Help line at **0800 111999**

## SAFETY

---

### WARNING

- If the hob surface is cracked, broken or shattered, switch off the appliance to avoid the possibility of electric shock and call for a service engineer's visit.
- During use the appliance becomes hot. Care should be taken to avoid touching heating elements.
- Children less than 8 years of age shall be kept away unless continuously supervised. This appliance can be used by children aged from 8 years and above and persons with reduced physical sensory or mental capabilities or lack of experience and knowledge if they have been given supervision or instruction concerning the use of the appliance in a safe way and understand the hazards involved. Children shall not play with the appliance. Cleaning and user maintenance shall not be made by children without supervision.
- Do not use harsh abrasive cleaners or sharp metal scrapers to clean the oven door glass or the hob, since they can scratch the surface, which may result in shattering of the glass.
- Do not use a steam cleaner on any cooking range, hob or oven appliance.
- Metallic objects such as knives, forks, spoons and lids should not be placed on the hob surface since they can get hot.
- After use, switch off the hob element by its control and do not rely on the pan detector.
- The appliance is not intended to be operated by means of an external timer or separate control system.
- Unattended cooking on a hob with fat or oil can be dangerous and may result in fire.
- NEVER try to extinguish a fire with water, but switch off the appliance and then cover the flame with a lid or damp cloth.
- Danger of fire: Do not store items on the cooking surfaces.
- Only use hob guards designed by the manufacturer of the cooking appliance or indicated by the manufacturer of the appliance in the instructions for use as suitable or hob guards incorporated in

the appliance. The use of inappropriate hob guards can cause accidents.

- This induction hob complies with the applicable EMC and EMF standards. Therefore it should not interfere with other electronic units. Persons fitted with a pacemaker or any other electrical implant should clarify with their doctor or the producer of the implant, whether their implant is adequate and fail-safe. Please place pans centrally on the cooking zones. The British Heart Foundation provide additional advice regarding using induction hobs when a pacemaker is fitted.
- During use the appliance becomes hot. Care should be taken to avoid touching heating elements.
- Do not modify this appliance.
- Do not place articles on or against the appliance.
- Servicing should be carried out only by authorised personnel.
- Always switch off your appliance and allow it to cool down before you clean any part of it.
- Although every care has been taken to ensure this appliance has no sharp edges. We recommend that you wear protective gloves when installing and moving this appliance. This will prevent injury.
- This appliance must be fitted to a switch providing all pole disconnection with a minimum contact separation of 3mm.
- Connection should be made with a suitable flexible cable with a minimum temperature rating of 70°C.

## **CAUTION**

- The cooking process has to be supervised. A short term cooking process has to be supervised continuously.
- This appliance must not be installed behind a decorative door in order to avoid overheating.
- **Fire Safety Advice**  
If you do have a fire in the kitchen, don't take any risks - get everyone out of your home and call the Fire Brigade.

### **If you have an electrical fire in the kitchen:**

- Pull the plug out, or switch off the power at the fuse box - this may be enough to stop the fire immediately
- Smother the fire with a fire blanket, or use a dry powder or carbon dioxide extinguisher
- Remember: never use water on an electrical or cooking oil fire.

- **Other Safety Advice**

- There is a risk of electric shock, so always make sure you have turned off and unplugged your appliance.
- This appliance must be earthed.
- The appliance must never be disconnected from the mains supply during use, as this will seriously affect the safety and performance, particularly in relation to surface temperatures becoming hot and gas operated parts not working efficiently.
- **GAS WARNING!** - If you smell gas: Do not try to light any appliance, Do not touch any electrical switch. Contact your local gas supplier immediately.



Report No.: GZES190802265932

Information for domestic electric hobs			P
	Symbol	Value	Unit
Model identification	—	BEL IHT603 BLK	
Type of hob	—	Built-in induction hob	
Number of cooking zones and/or areas	—	4 zones	
Heating technology (induction cooking zones and cooking areas, radiant cooking zones, solid plates)	—	Induction cooking zones	
For circular cooking zones or area: diameter of useful surface area per electric heated cooking zone, rounded to the nearest 5 mm	∅	Zone1: 16,0 Zone2: 21,0 Zone3: 18,0 Zone4: 18,0	cm
For non-circular cooking zones or areas: length and width of useful surface area per electric heated cooking zone or area, rounded to the nearest 5 mm	L, W	---	cm
Energy consumption per cooking zone or area calculated per kg	EC <sub>electric cooking</sub>	Zone1: 196,3 Zone2: 182,0 Zone3: 186,3 Zone4: 187,6	Wh/kg
Energy consumption for the hob calculated per kg	EC <sub>electric hob</sub>	188,1	Wh/kg

# USING YOUR APPLIANCE

## Getting to know your product

**Note:** Your appliance layout may differ depending on the model.

### Control Panel

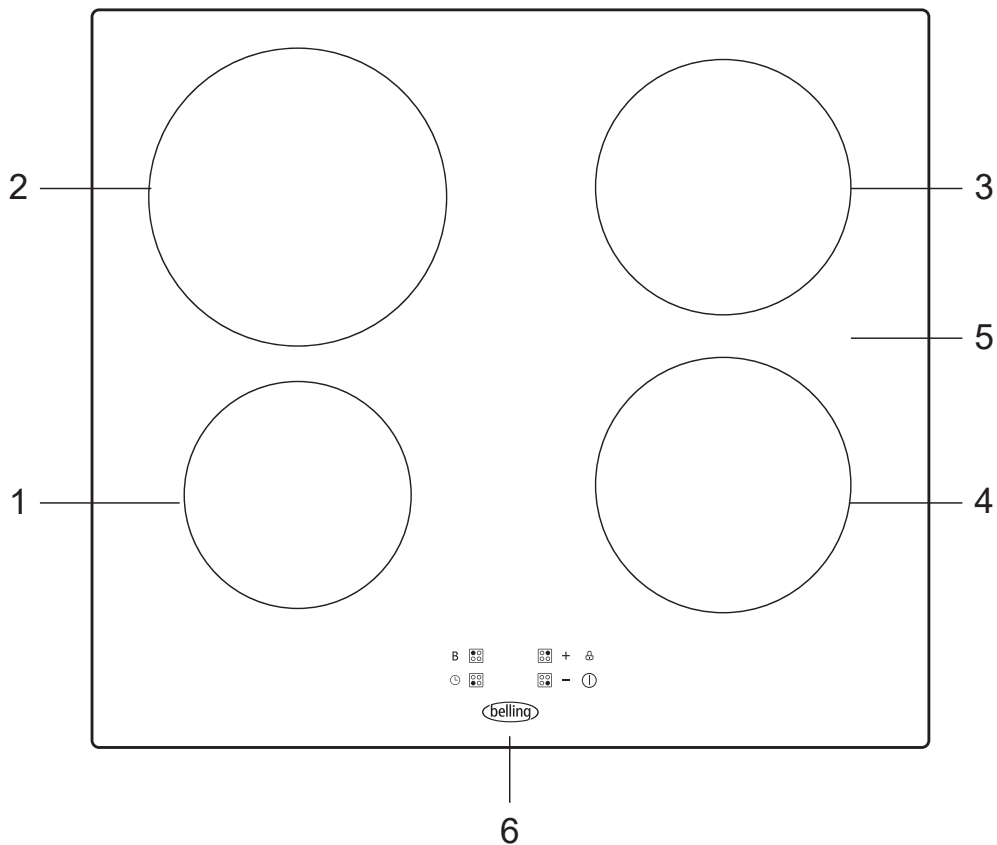

- 1. Max. 1300/1500W zone
- 2. Max. 2300/2600W zone
- 3. Max. 1800/2000W zone
- 4. Max. 1800/2000W zone
- 5. Glass plate
- 6. Control panel

### Hob functions

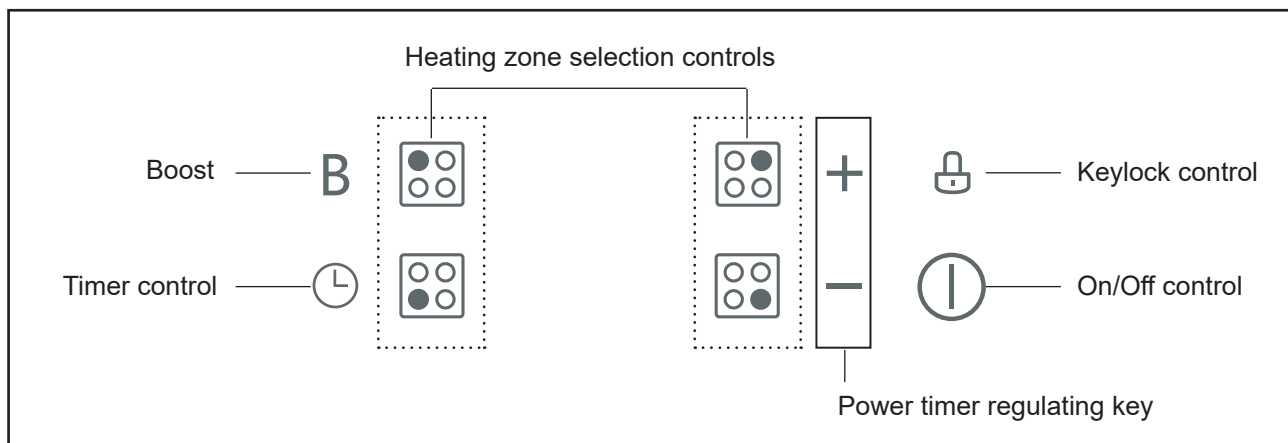



## Before using the Hob

- Read this guide, taking special note of the 'Safety Warnings' section.
- Remove any protective film that may still be on your hob.

## Touch controls

Use the flat of your finger, not the tip. The controls respond to touch, so you don't need to apply any pressure. The touch control keys take approximately 1 second to respond to your touch. Always ensure the touch control area is clean, dry and free from any objects (e.g. utensils, tea towels and cloths), spillages and water may make the controls difficult to operate.

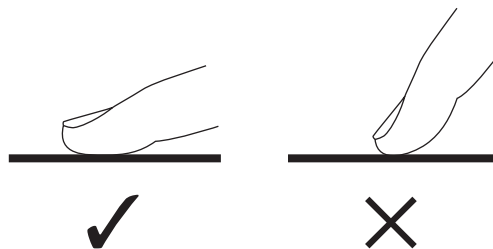

## Choosing the right Cookware

- Only use cookware with a base suitable for induction cooking. Look for the induction symbol on the packaging or on the bottom of the pan.
- You can check whether your cookware is suitable by carrying out a magnet test. Move a magnet towards the base of the pan. If it is attracted, the pan is suitable for induction. The base of the pan must be magnetic across the whole diameter of the base.
- If you do not have a magnet:
  1. Put some water in the pan you want to check.
  2. If  does not flash in the display and the water is heating, the pan is suitable.
- Cookware made from the following materials are not suitable: pure stainless steel, aluminium or copper without a magnetic base, glass, wood, porcelain, ceramic, and earthenware.

Do not use cookware with jagged edges or a curved base.

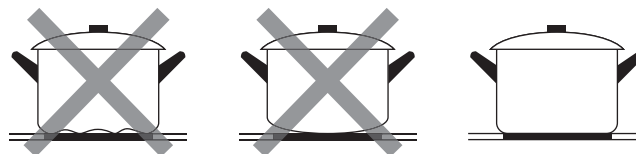



Make sure that the base of your pan is smooth, sits flat against the glass. Use a pan which is at least as large as the circle printed on the glass. Using a pan which is slightly wider than the glass circle printed on the glass will maximise energy-efficiency Always centre your pan on the cooking zone.

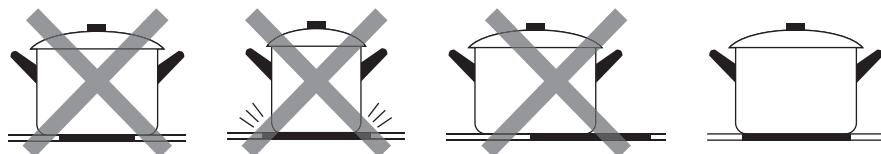

Always lift pans off the hob – do not slide, or they may scratch the glass.

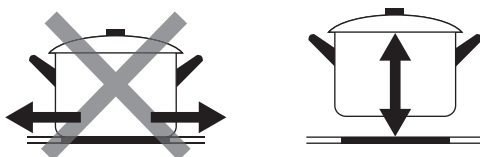

## Start cooking

After switching the hob on, the buzzer will beep once. All the indicator lights light up for a second to indicate that the induction hob is now in standby mode.

1. Touch the On/Off key for a few seconds until the buzzer beeps once and the displays show '-' or '--' to indicate that the hob is in standby mode.

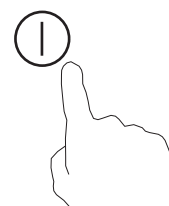

2. Place a suitable pan on the cooking zone that you wish to use.

- Make sure the bottom of the pan and the bottom of the cooking zone are clean and dry.

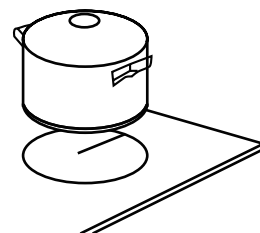

3. Touch the relevant heating zone selection control key for the zone you wish to use, until the power level indicator next to it starts to flash.

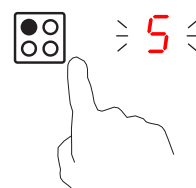

4. Select a heat setting by touching the “-” or “+” control.

- If you don't select a heat setting within about 1 minute, the induction hob will automatically switch off. You would then need to start again from step 1.
- You can modify the heat setting at any time during cooking.

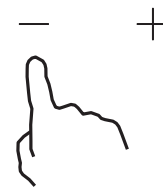

## If the display flashes alternately with the heat setting

This means that:

- You have not placed a pan on the correct cooking zone or;
- The pan you're using is not suitable for induction cooking or;
- The pan is too small or not properly centered on the cooking zone.

No heating takes place unless there is a suitable pan on the cooking zone. The display “” will automatically turn off after 1 minute if no suitable pan is placed on it.

## Finish cooking

Touch the relevant heating zone selection control key for the zone that you wish to switch off.

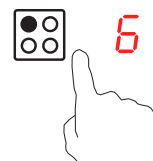

Ensure the heating zone is selected and flashing.  
Turn the cooking zone off by scrolling down to “0” or touching “-” and “+” control together. Make sure the display shows “0”.



Turn the whole hob off by touching the On/Off control key.

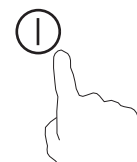

## Beware of hot surfaces

H will show which cooking zone is hot to touch. It will disappear when the surface has cooled down to a safe temperature.

This can also be used to save energy if you wish to heat other pans, use the hotplate that is still hot.



# Using the Boost function

## To activate

1. First select the relevant heating zone by touching the relevant heating zone selection key.

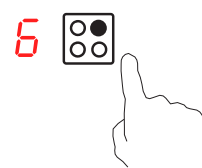

2. Touch the power boost control key. The zone indicator display shows 'P' and the zone works on maximum power.

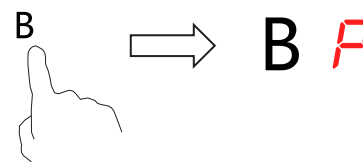

## To cancel

1. If you wish to cancel the boost function before this, select the relevant heating zone by touching the relevant heating zone selection key.

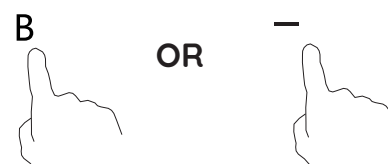

2. Touch the power boost control key or the “-” button to cancel the power boost function. The zone will revert to the on-going power level.

3. Ensure the cooking zone is selected and flashing. Touch the “-” and “+” control keys together. The cooking zone will switch off and the boost function will be automatically cancelled.

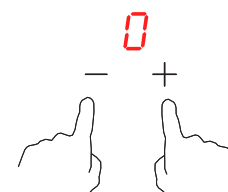

- The power boost function is available to all 4 cooking zones, however you cannot boost all 4 cooking zones at the same time. You can only boost one zone from each pair at the same time.
- The power boost function is automatically cancelled after about 5 minutes, and the zone reverts to the ongoing power level.
- If no on-going power level was set prior to activating the power boost function, then the zone will revert to power level 9 when the power boost function comes to an end.
- The power boost function involves one zone ‘borrowing’ some power from the adjacent zone. Therefore, if zone 2 (the back-left zone) is on power boost, zone 1 (the front-left zone) can only be used up to power level 7.
- If the front-left zone is on power boost, the back-left zone can only be used up to power level 7.

## Locking and unlocking the Controls

- You can lock the controls to prevent unintended use (for example children accidentally turning the cooking zones on).
- When the controls are locked, all the controls except the On/Off control are disabled.

### To lock

1. Touch and hold the keylock control  key. The timer display will show “Lo”.

### To unlock

**Note: Make sure the hob is turned on.**

1. Touch and hold the keylock control  key until “Lo” disappears from the timer display.

When the keylock function is active, all of the controls are disabled except for the on/off key, so that you can switch the hob off. If you do switch the hob off in this situation, you must first touch and hold the lock key for a few seconds until “LO” disappears from the timer display, before you can switch the hob back on.

## Timer control

You can use the timer in two different ways:

1. You can use it as a minute minder. In this case, the timer will not turn any cooking zone off when the set time has elapsed.
2. You can also set it to turn one or more cooking zones off after the set time has elapsed. Refer to Setting the timer to turn one or more cooking zones off.

A maximum duration time of 99 minutes can be set.

## Using the Timer as a Minute Minder

### If you are not selecting any cooking zone

1. Make sure the hob is turned on.

**Note:** You can use the minute minder. At least one zone should be active.

2. Touch the timer control key. The timer display starts flashing and shows the default value of 10 minutes.
3. Set the time by touching the “-” or “+” control keys.

Touch the “-” or “+” control keys once to decrease or increase by 1 minute.

Touch and hold the “-” or “+” control keys to decrease or increase by 10 minutes.

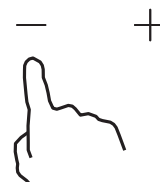
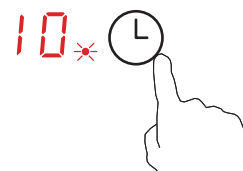

4. Touch the “-” and “+” control keys together to cancel the timer. “00” will show in the minute display.

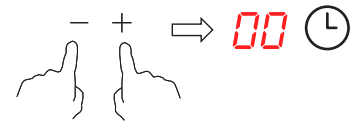

5. Once the timer has been set it will count down immediately. The display will show the remaining time and the timer indicator will flash for 5 seconds.



If you need to change the minute minder duration time, please repeat steps 2-3 above. Adjusting the time down to 00 would cancel the minute minder function.

6. When the minute minder duration time has elapsed, the buzzer will beep for 30 seconds and ‘--’ shows in the timer display.



## Setting the timer to turn one or more cooking zones off

1. First select the cooking zone you wish to use by touching the relevant heating zone selection control key.

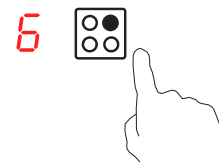

2. Immediately, touch the timer control key, the timer display will start flashing and “10” will show in the timer display.

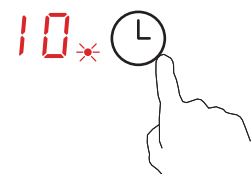

3. Set the time by touching the “-” or “+” control keys.

Touch the “-” or “+” control keys once to decrease or increase by 1 minute.

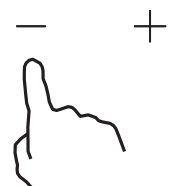

Touch and hold the “-” or “+” control keys to decrease or increase by 10 minutes.

4. Touch the “-” and “+” control keys together to cancel the timer. “00” will show in the minute display.



5. Once the timer has been set it will count down immediately. The display will show the remaining time and the timer indicator will flash for 5 seconds.



**NOTE:** A red dot flashes next to the relevant cooking zone power level indicator, to show that the zone is currently being controlled by the timer.



6. When the cooking duration time has elapsed, the relevant zone will switch off automatically.



**Note:** If there are other cooking zones in use, which are not being controlled by the timer, then they will continue to operate when the cooking duration time has elapsed, and will not be switched off automatically.

## Residual Heat Warning

“H” will show which cooking zone is hot to touch. It will disappear when the surface has cooled down to a safe temperature. It can also be used as an energy saving function if you want to heat further pans, use the hotplate that is still hot.

Note: Please be aware that the glass surface may still be warm for a while, even after the ‘H’ indicator has disappeared.

## Default working times

Auto shut down is a safety protection function for your induction hob. It shuts down automatically if ever you forget to turn off a cooking zone. The default working times for various power levels are shown in the below table:

Power level	1	2	3	4	5	6	7	8	9
Default working timer (hour)	8	8	8	4	4	4	2	2	2

When the pan is removed, the induction hob will stop heating immediately and the hob will automatically switch off after 2 minutes.

People with a heart pace maker should consult with their doctor before using this unit.

## Controlling more than one zone with the timer

If you wish to control more than one zone with the timer, please repeat steps 2-5 above.

The timer display will always show the remaining cooking time for the zone which is due to finish first.

When you set the time for several cooking zones simultaneously, decimal dots of the relevant cooking zones are on. The timer display shows the time remaining for the zone which is due to finish first. The dot of the corresponding zone flashes.

When the cooking duration time for the zone due to finish first has elapsed, that zone is switched off automatically. The timer display will then change to show the cooking time remaining for the zone which is due to finish second.

If you want to see how long a zone has left to run, touch the heating zone selection control key for the relevant zone and the time remaining will be displayed briefly on the timer display.

## Cancelling the cook-to-off timer.

1. Touch the relevant heating zone selection control for the zone on which you wish to cancel the timer. The power level indicator next to that zone will start to flash.
2. While the power level indicator is flashing, touch the timer control key. The timer display starts to flash.
3. While the timer display is flashing, touch the “-” and “+” control keys together to cancel the timer. “00” will show in the minute display.



## Heat Settings

The settings below are guidelines only. The exact setting will depend on several factors, including your cookware and the amount you are cooking. Experiment with the induction hob to find the settings that best suit you.

Heat Setting	Suitability
1 - 2	<ul style="list-style-type: none"><li>• Delicate warming for small amounts of food.</li><li>• Melting chocolate, butter, and foods that burn quickly</li><li>• Gentle simmering</li><li>• Slow warming</li></ul>
3 - 4	<ul style="list-style-type: none"><li>• Reheating</li><li>• Rapid simmering</li><li>• Cooking rice</li></ul>
5 - 6	<ul style="list-style-type: none"><li>• Pancakes</li></ul>
7 - 8	<ul style="list-style-type: none"><li>• Sautéing</li><li>• Cooking pasta</li></ul>
9/Power boost	<ul style="list-style-type: none"><li>• Stir-frying</li><li>• Searing</li><li>• Bringing soup to boil</li><li>• Boiling water</li></ul>

## Care and cleaning

What ?	How ?	Important !
<p>Everyday soiling on glass (fingerprints, marks, stains left by food or non-sugary spillovers on the glass)</p>	<ol style="list-style-type: none"> <li>1. Switch the power to the cooktop off.</li> <li>2. Apply a cooktop cleaner while the glass is still warm (but not hot!)</li> <li>3. Rinse and wipe dry with a clean cloth or paper towel.</li> <li>4. Switch the power to the cooktop back on.</li> </ol>	<ul style="list-style-type: none"> <li>• When the power to the cooktop is switched off, there will be no 'hot surface' indication but the cooking zone may still be hot! Take extreme care.</li> <li>• Heavy-duty scourers, some nylon scourers and harsh/abrasive cleaning agents may scratch the glass. Always read the label to check if your cleaner or scourer is suitable.</li> <li>• Never leave cleaning residue on the cooktop: the glass may become stained.</li> </ul>
<p>Boilovers, melts, and hot sugary spills on the glass</p>	<p>Remove these immediately with a fish slice, palette knife or razor blade scraper suitable for Induction glass cooktops, but beware of hot cooking zone surfaces:</p> <ol style="list-style-type: none"> <li>1. Switch the power to the cooktop off at the wall.</li> <li>2. Hold the blade or utensil at a 30° angle and scrape the soiling or spill to a cool area of the cooktop.</li> <li>3. Clean the soiling or spill up with a dish cloth or paper towel.</li> <li>4. Follow steps 2 to 4 for 'Everyday soiling on glass' above.</li> </ol>	<ul style="list-style-type: none"> <li>• Remove stains left by melts and sugary food or spillovers as soon as possible. If left to cool on the glass, they may be difficult to remove or even permanently damage the glass surface.</li> <li>• Cut hazard: when the safety cover is retracted, the blade in a scraper is razor-sharp. Use with extreme care and always store safely and out of reach of children.</li> </ul>
<p>Spillovers on the touch controls</p>	<ol style="list-style-type: none"> <li>1. Switch the power to the cooktop off.</li> <li>2. Soak up the spill</li> <li>3. Wipe the touch control area with a clean damp sponge or cloth.</li> <li>4. Wipe the area completely dry with a paper towel.</li> <li>5. Switch the power to the cooktop back on.</li> </ol>	<ul style="list-style-type: none"> <li>• The cooktop may beep and turn itself off, and the touch controls may not function while there is liquid on them. Make sure you wipe the touch control area dry before turning the cooktop back on.</li> </ul>

## Troubleshooting

Problem	Possible causes	What to do
The induction hob cannot be turned on.	No power.	Make sure the induction hob is connected to the power supply and that it is switched on. Check whether there is a power outage in your home or area. If you've checked everything and the problem persists, call a qualified technician.
The touch controls are unresponsive.	The controls are locked.	Unlock the controls. See section 'Using your induction cooktop' for instructions.
The touch controls are difficult to operate.	There may be a slight film of water over the controls or you may be using the tip of your finger when touching the controls.	Make sure the touch control area is dry and use the ball of your finger when touching the controls.
The glass is being scratched.	Rough-edged cookware.  Unsuitable, abrasive scourer or cleaning products being used.	Use cookware with flat and smooth bases. See 'Choosing the right cookware'.  See 'Care and cleaning'.
Some pans make crackling or clicking noises.	This may be caused by the construction of your cookware (layers of different metals vibrating differently).	This is normal for cookware and does not indicate a fault.
The induction hob makes a low humming noise when used on a high heat setting.	This is caused by the technology of induction cooking.	This is normal, but the noise should quieten down or disappear completely when you decrease the heat setting.
Fan noise coming from the induction hob.	A cooling fan built into your induction hob has come on to prevent the electronics from overheating. It may continue to run even after you've turned the induction hob off.	This is normal and needs no action. Do not switch the power to the induction hob off at the wall while the fan is running.
Pans do not become hot and "U" appears in the display.	The induction hob cannot detect the pan because it is not suitable for induction cooking.  The induction hob cannot detect the pan because it is too small for the cooking zone or not properly centred on it.	Use cookware suitable for induction cooking. See section 'Choosing the right cookware'.  Centre the pan and make sure that its base matches the size of the cooking zone.
The induction hob or a cooking zone has turned itself off unexpectedly, a tone sounds and an error code is displayed (typically alternating with one or two digits in the cooking timer display).	Technical fault.	Please note down the error letters and numbers, switch the power to the induction hob off at the wall, and contact a qualified technician.

# Troubleshooting

The induction hob is equipped with a self diagnostic function. With this test the technician is able to check the function of several components without disassembling or dismantling the hob from the working surface.

## Troubleshooting

1) Failure code occurring during customer use & solution;

Failure code	Problem	Solution
<b>No Auto-Recovery</b>		
<b>E1</b>	Ceramic plate temperature sensor failure--open circuit.	Check the connection or replace the ceramic plate temperature sensor.
<b>E2</b>	Ceramic plate temperature sensor failure--short circuit.	
<b>Eb</b>	Ceramic plate temperature sensor failure.	
<b>E3</b>	High temperature of ceramic plate sensor.	Wait for the temperature of ceramic plate return to normal. Touch "ON/OFF" button to restart unit.
<b>E4</b>	Temperature sensor of the IGBT failure -- open circuit.	Replace the power board.
<b>E5</b>	Temperature sensor of the IGBT failure -- short circuit	
<b>E6</b>	High temperature of IGBT.	Wait for the temperature of IGBT return to normal. Touch "ON/OFF" button to restart unit. Check whether the fan runs smoothly; if not, replace the fan.
<b>E7</b>	Supply voltage is below the rated voltage.	Please inspect whether power supply is normal.
<b>E8</b>	Supply voltage is above the rated voltage.	Power on after the power supply is normal.
<b>U1</b>	Communication error.	Reinsert the connection between the display board and the power board. Replace the power board or the display board.

## 2) Specific Failure & Solution

Failure	Problem	Solution A	Solution B
The LED does not come on when unit is plugged in.	No power supplied.	Check that appliance is switched on at the fused spur cooker point on the wall.	
	Request a service visit. Engineer to check the connection between the powerboard and display board.	Check the connection.	
	The accessorial power board is damaged.	Replace the accessorial power board.	
	The display board is damaged.	Replace the display board.	
Some buttons can't work, or the LED display is not normal.	The display board is damaged.	Request a service visit.	
The Cooking Mode Indicator comes on, but heating does not start.	High temperature of the hob.	Switch the hob off and let it cool down.	
		Check the installation to ensure that the air inlets and outlets are not blocked.	
	There is something wrong with the fan.	Check whether the fan runs smoothly; if not, replace the fan.	
	The power board is damaged.	Replace the power board.	
Heating stops suddenly during operation and the display flashes "U".	Pan type is wrong.	Use the proper pan (refer to the instruction manual.)	Pan detection circuit is damaged, replace the power board.
	Pot diameter is too small.		
	Hob has overheated.	Unit is overheated. Wait for temperature to return to normal. Push "ON/OFF" button to restart unit.	
Adjacent zones on the same side of the hob (such as the first and second zones) display "U".	Possible loose connection between the powerboard and the display board.	Check the connection.	
	Possible failure of the display board.	Replace the display board.	
	Possible failure of the powerboard.	Replace the power board.	
Fan motor sounds abnormal.	Request a service visit.	Replace the fan.	

# CLEANING YOUR APPLIANCE

## Do's

**Note:** Always switch off your appliance and allow it to cool down before you clean any part of it.

**Note:** Please take extra care when cleaning over the symbols on the control panel, as this can lead to them fading.

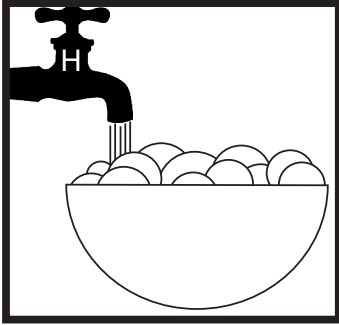

- Warm, soapy water

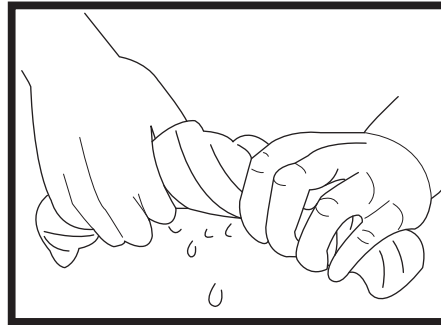

- Clean, wringing out cloth

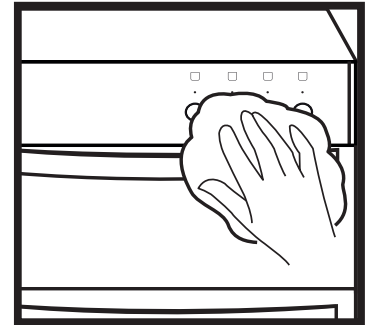

- Wipe with damp cloth
- Dry with a soft cloth

**Tips:** Some foods can mark or damage the metal or paint work e.g.; Vinegar, fruit juices and salt. Always clean food spillages as soon as possible.

## Dont's

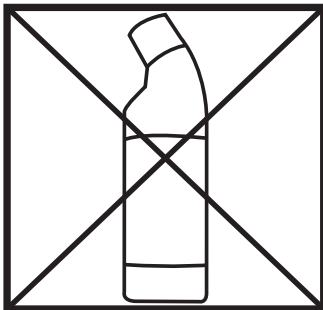

- Undiluted bleaches
- Chloride products

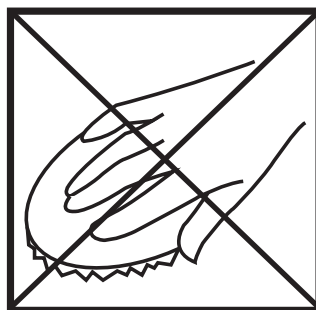

- Wire Wool
- Abrasive cleaners
- Nylon pads
- Steam cleaners

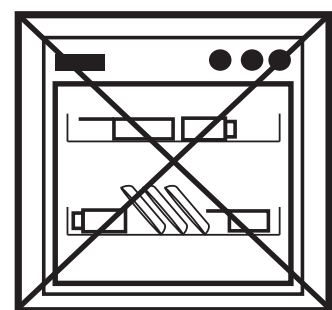

- Do not place in the dishwasher:
- Cast iron griddle
  - Pan supports

**IT IS IMPORTANT TO CLEAN YOUR APPLIANCE REGULARLY AS A BUILD UP OF FAT CAN AFFECT IT'S PERFORMANCE OR DAMAGE IT AND MAY INVALIDATE YOUR GUARANTEE.**

We offer a great range of cleaning products and accessories for your appliance.  
To shop, please visit [www.gdhaonline.co.uk](http://www.gdhaonline.co.uk)

# Installation

## Preparing the worktop cut out

Make a cut-out in the worktop according to the dimensions shown in the table.

For the purpose of installation and use, a minimum of 5cm space shall be preserved around the hole.

Be sure the thickness of the work surface is at least 30mm. Please ensure the worktop is made of heat-resistant material to prevent deformations caused by heat from the appliance.

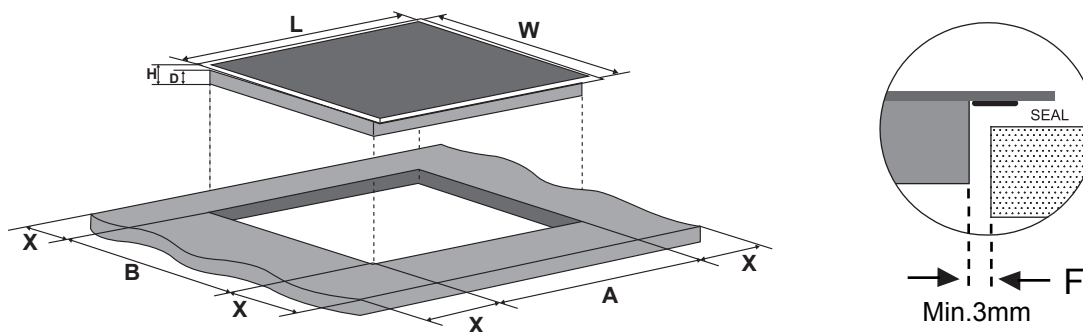

L(mm)	W(mm)	H(mm)	D(mm)	A(mm)	B(mm)	X(mm)	F(mm)
590	520	62	58	560+4 +1	490+4 +1	50 min.	3 min.

Ensure that the induction hob is well-ventilated and that the air inlet and outlets are not blocked. Make sure that the hob is not damaged in any way. Do not install a damaged hob.

**Note:** The safety distance between the hotplate and the cupboard above the hotplate should be at least 760mm.

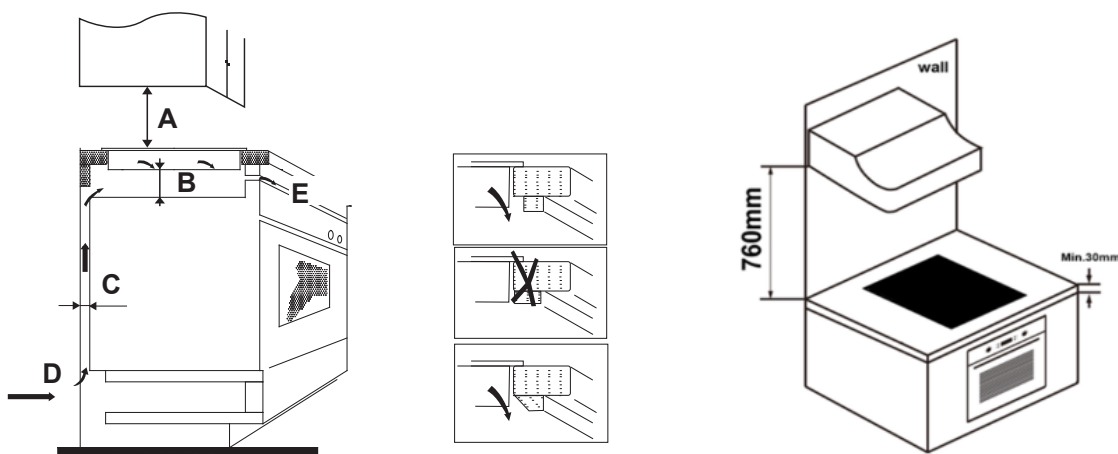

A(mm)	B(mm)	C(mm)	D	E
760	50 min.	20 min.	Air intake	Air exit 5mm



## WARNING: Ensuring Adequate Ventilation

Make sure the induction cooker hob is well ventilated and that air inlet and outlet are not blocked. In order to avoid accidental touch with the overheating bottom of the hob, or getting unexpected electric shock during working, it is necessary to put a wooden insert, fixed by screws, at a minimum distance of 50mm from the bottom of the hob. Follow the requirements below.

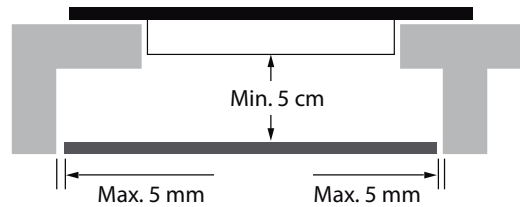

There are ventilation holes around outside of the hob. YOU MUST ensure these holes are not blocked by the worktop when you put the hob into position.

- Be aware that the glue that joins the plastic or wooden material to the furniture, has to resist to temperature not below 150°C, to avoid the paneling becoming unstuck.
- The rear wall, adjacent and surrounding surfaces must therefore be able to withstand an temperature of 90°C.

## Before installation

- The work surface is square and level, and no structural members interfere with space requirements.
- The work surface is made of a heat-resistant material and insulated material.
- If the hob is installed above an oven, the oven has a built-in cooling fan.
- The installation will comply with all clearance requirements and applicable standards and regulations.
- A suitable isolating switch providing full disconnection from the mains power supply is incorporated in the permanent wiring, mounted and positioned to comply with the local wiring rules and regulations.
- The isolating switch must be of an approved type and provide a 3 mm air gap contact separation in all poles (or in all active [phase] conductors if the local wiring rules allow for this variation of the requirements).
- The isolating switch will be easily accessible to the customer with the hob installed.
- You consult local building authorities and by-laws if in doubt regarding installation.
- You use heat-resistant and easy-to-clean finishes (such as ceramic tiles) for the wall surfaces surrounding the hob.

## After installation

- The power supply cable is not accessible through cupboard doors or drawers.
- There is adequate flow of fresh air from outside the cabinetry to the base of the hob.
- If the hob is installed above a drawer or cupboard space, a thermal protection barrier is installed below the base of the hob.
- The isolating switch is easily accessible by the customer.

## Before locating the fixing brackets

The unit should be placed on a stable, smooth surface (use the packaging). Do not apply force to the controls protruding from the hob.

## Adjusting the bracket position

Once the hob has been placed into the worktop with the worktop seal, screw the installation brackets to the underside of the hob. The installation brackets can be installed either way up depending on the thickness of the worktop. There should be a small gap between the installation brackets and the underside of the worktop to allow space for heat expansion.

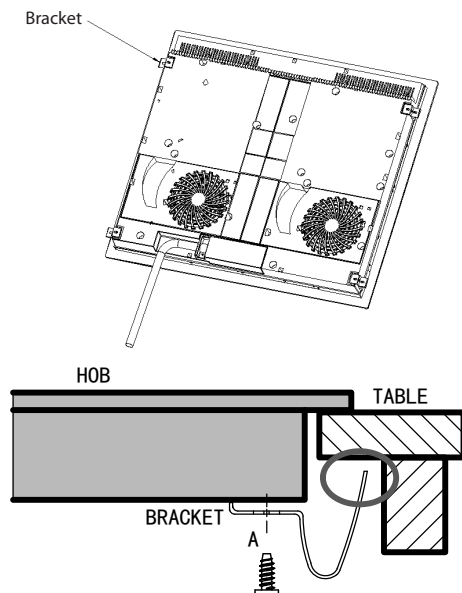

Under any circumstances, the brackets cannot touch the inner surfaces of the worktop after installation (see picture).

## Cautions

1. The induction hotplate must be installed by qualified personnel or technicians. We have professionals at your service. Please never conduct the operation by yourself.
2. The hob will not be installed directly above a dishwasher, fridge, freezer, washing machine or clothes dryer, as the humidity may damage the hob electronics.
3. The induction hotplate shall be installed such that better heat radiation can be ensured to enhance its reliability.
4. The wall and induced heating zone above the table surface shall withstand heat.
5. To avoid any damage, the sandwich layer and adhesive must be resistant to heat.
6. A steam cleaner is not to be used.

## Connecting the hob to the mains power supply

**Warning:** This appliance must be earthed.

This hob must be connected to the mains power supply only by a suitably qualified person.

Before connecting the hob to the mains power supply, check that:

1. The domestic wiring system is suitable for the power drawn by the hob.
2. The voltage corresponds to the value given in the rating plate.
3. The power supply cable sections can withstand the load specified on the rating plate.

To connect the hob to the mains power supply, do not use adapters, reducers, or branching devices, as they can cause overheating and fire.

The power supply cable must not touch any hot parts and must be positioned so that its temperature will not exceed 75°C at any point.

Check with an electrician whether the domestic wiring system is suitable without alterations. Any alterations must only be made by a qualified electrician.

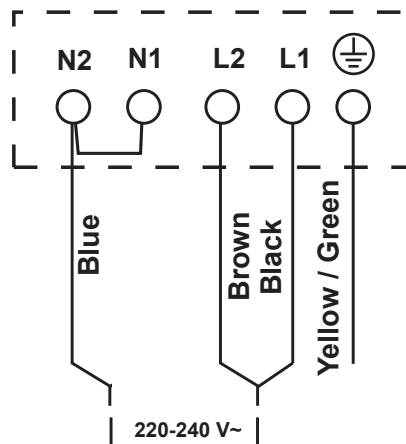

- If the cable is damaged or to be replaced, the operation must be carried out by the service agent with dedicated tools to avoid any accidents.
- If the appliance is being connected directly to the mains electricity supply, an omnipolar circuit-breaker must be installed with a minimum opening of 3mm between contacts.
- The installer must ensure that the correct electrical connection has been made and that it is compliant with safety regulations.
- The cable must not be bent or compressed.
- The cable must be checked regularly and replaced by authorised technicians only.

**This appliance comes with the power cable supplied (1.2m 4 core 2.5mm<sup>2</sup>).**

## **Connect to the electricity supply**

**Warning:** Ensure that the power rating of the appliance is compatible with a 25Amp supply before connecting to the electricity supply. Check with an electrician whether the domestic wiring system is suitable without alterations.

Should the mains lead of the appliance ever require replacing, we recommend that this is carried out by a qualified electrician who will replace it with a lead of the same size and temperature rating.

The bottom surface and the power cord of the hob are not accessible after installation.

## Customer Care

Please keep this handbook in a safe place as the information inside may be of use should you sell, or pass on the appliance. Please fill in the model number and serial number in the spaces provided below as they will assist us should you need to call.

# 0344 815 3746

When you dial this number, you will hear a recorded message and be given several options. This indicates that your call has been accepted and is being held in a queue. Calls are answered in strict rotation as our Customer Care representatives become available.

Enter appliance number here for future reference:

<b>Model No</b>									
4	4	4							
<b>Serial No</b>									

These numbers can be found on your appliances data badge. Outside the UK and Northern Ireland, refer to your local supplier.



**Stoney Lane, Prescott, Merseyside, L35 2XW.**

# TECHNICAL DATA

---

## Hob Details

<b>Cooking hob</b>	BEL IHT603 BLK
Cooking Zones	4 Zones
Supply Voltage	220-240V~ 50Hz or 60Hz
Installed Electric Power	7200W
Product Size D x W x H (mm)	590 X 520 X 62
Building-in Dimensions A x B (mm)	560 X 490

Weight and Dimensions are approximate. Because we continually strive to improve our products we may change specifications and designs without prior notice.