



WOODLAND ELECTRIC STOVE

USER INSTRUCTIONS AND INSTALLATION



Version 1 27/10/23

Contents of manual may be updated without notice.

For the latest version of this manual please refer to our
website: www.eurostove.co.uk

IMPORTANT NOTE

THE HEATER OUTLET GRILLE BECOMES VERY HOT WHILST IN OPERATION. DO NOT COVER THE OUTLET GRILLE OR ANY PART OF THE APPLIANCE. FOR USE WITH 230V - 240V 50HZ ELECTRICITY SUPPLY ONLY. PLEASE READ THESE INSTRUCTIONS CAREFULLY BEFORE INSTALLATION KEEP THE INSTRUCTIONS IN A SAFE PLACE.THEY WILL BE NEEDED WHEN MAINTENANCE OR SERVICING IS REQUIRED. THIS APPLIANCE MUST BE EARTHED.

USER MANUAL CONTENTS

BOX CONTENTS	3
HOW TO USE YOUR APPLIANCE	
1. IMPORTANT SAFETY INFORMATION	4
2. APP CONNECTING INSTRUCTIONS	6
3. REMOTE CONTROL INSTRUCTIONS	12
4. OPERATING INSTRUCTION	13
5. MAINTENANCE AND CARE	14
HOW TO INSTALL YOUR APPLIANCE	
6. TECHNICAL SPECIFICATION	15
7. GENERAL INSTALLATION	16
8. INSTALLATION	17
SERVICING INSTRUCTIONS	
9. SETTING FUEL BED	18
10. ELECTRICAL CONNECTION	19
11. GENERAL INFORMATION	20
12. FAULT FINDING	21
REFERENCE INFORMATION	
13. WIRING DIAGRAM	22
14. EXPLODED DIAGRAM	23

TERMS AND CONDITIONS WARRANTY

EUROSTOVE LTD

UNIT H1

MENDIP INDUSTRIAL ESTATE ROOKSBRIDGE

SOMERSET BS26 2UG

FULL TERMS AND CONDITIONS ARE DETAILED
IN THE WARRANTY STATEMENT ON THE
WEBSITE WWW.PAULAGNEWDESIGNS.COM.AU.

IN THE EVENT OF ANY CONFLICT OF
INFORMATION THE WORDING ON THE WEBSITE
SHALL PREVAIL. IMPORTANT NOTE: SHOULD
ANY PROBLEMS BE EXPERIENCED WITH YOUR
PRODUCT, CLAIMS MUST FIRST BE SUBMITTED
TO THE RETAILER WHERE THE APPLIANCE
WAS PURCHASED FROM WHO WILL OFFER
IMMEDIATE ASSISTANCE.

REGISTRATION NUMBER:

IN ACCORDANCE WITH EUROPEAN DIRECTIVE
2012/19/ EU, WASTE ELECTRICAL AND
ELECTRONIC EQUIPMENT (WEEE) MUST NOT
BE DISPOSED OF WITH HOUSEHOLD WASTE.
AT THE END OF ITS USEFUL LIFE PLEASE TAKE
THIS PRODUCT TO AN APPROPRIATE
RECYCLING CENTRE OR COLLECTION POINT.
YOU CAN FIND

YOUR NEAREST RECYCLING CENTRE BY USING
THE BANK LOCATOR AT
WWW.RECYCLE-MORE.CO.UK FOR UK
CUSTOMERS,
WWW.ACOR.ORG.AU FOR AUSTRALIA
CUSTOMERS
WWW.WEEEIRELAND.IE FOR CUSTOMERS
IN THE REPUBLIC OF IRELAND, OR BY
CONTACTING YOUR LOCAL AUTHORITY



BOX CONTENTS

PLEASE CHECK THAT THE FOLLOWING COMPONENTS ARE INCLUDED WITHIN THE BOX. IF ANYTHING IS MISSING OR DAMAGED, PLEASE CONTACT THE RETAILER AND DO NOT USE THE APPIANCE UNTIL YOU HAVE EVERYTHING.

- APPLIANCE WITH TRAILING LEAD WITH MOULDED 13AMP
- PLUG REMOTE CONTROLHANDSET AND BATTERIES.
- INSTRUCTION MANUAL.
- LOG SET.
- BLACK COAL.
- BLACK EMBER CRYSTALS.

HOW TO USE YOUR APPLIANCE

1. IMPORTANT SAFETY INFORMATION

- READ ALL OF THE INSTRUCTIONS CAREFULLY BEFORE USING THE APPLIANCE. INSTRUCTIONS ARE AVAILABLE ONLINE AT WWW.PAULAGNEWDESIGNS.COM
- REMOVE ALL PACKAGING AND DISPOSE OF AT AN APPROPRIATE RECYCLING FACILITY.
- DO NOT USE THIS APPLIANCE IN THE IMMEDIATE SURROUNDINGS OF A BATH, SHOWER, SWIMMING POOL OR ANY OTHER AREA WHERE THE APPLIANCE COULD COME INTO CONTACT WITH WATER OR HUMIDITY, E.G. A BATHROOM.
- DO NOT ALLOW THE APPLIANCE TO BE COVERED OR LET THE AIR INLET/OUTLET BECOME OBSTRUCTED AS THE APPLIANCE MAY OVERHEAT. PLEASE NOTE THE WARNING SYMBOL ON THE APPLIANCE. FOR INDOOR USE ONLY. THIS APPLIANCE IS NOT SUITABLE FOR USE OUTSIDE THE HOUSE.
- KEEP THE POWER CORD AWAY FROM HOT SURFACES AND HOT CONDITIONS. DO NOT ROUTE THE POWER LEAD IN FRONT OF THE APPLIANCE.
- THIS APPLIANCE MUST BE INSTALLED IN A PURPOSE BUILT STUD-WORK ENCLOSURE OR A SUITABLY PREPARED FIREPLACE
- . ENSURE THE APPLIANCE IS LEVEL AND THAT FURNITURE, CURTAINS ETC. ARE POSITIONED NO CLOSER THAN 1M.
- WHEN THE APPLIANCE HAS BEEN INSTALLED THE POSITION OF THE PLUG MUST BE ACCESSIBLE OR AN ISOLATION SWITCH WILL BE INSTALLED AWAY FROM THE APPLIANCE.
- WHERE THE ELECTRICITY SUPPLY CABLE HAS TO PASS THROUGH A MASONRY WALL, STONE SURROUND ETC. ENSURE SUITABLE RUBBER BUSHES ARE FITTED AT POSSIBLE WEAR POINTS.
- **NEVER** LEAVE CHILDREN UNSUPERVISED WITH AN UNGUARDED HEATER.
- **NEVER** OBSTRUCT OR COVER THE HEATER OUTLET.
- **NEVER** INSTALL OR USE THIS PRODUCT WHERE IT MAY COME IN CONTACT WITH WATER I.E. A BATHROOM OR WET ROOM.
- **NEVER** USE AEROSOLS OR STEAM CLEANERS NEAR THIS PRODUCT.
- **NEVER** ROUTE THE ELECTRIC CABLE NEAR THE HEATER OUTLET.
- **NEVER** ROUTE THE ELECTRIC CABLE UNDER CARPETS OR FLOOR COVERINGS.
- **NEVER** INSTALL THIS PRODUCT CLOSE TO CURTAINS OR COMBUSTIBLE MATERIALS.
- **NEVER** USE THE HEATER TO DRY CLOTHES OR OTHER OBJECTS.
- **NEVER** REMOVE THE FIREPLACE SURROUNDING WITHOUT ISOLATING THE ELECTRIC SUPPLY.

HOW TO USE YOUR APPLIANCE

1. IMPORTANT SAFETY INFORMATION

- IF THE ELECTRICITY SUPPLY CABLE IS DAMAGED DO NOT USE THE APPLIANCE UNTIL IT HAS BEEN REPLACED. FOR SAFETY REASONS THE REPLACEMENT HAS TO BE CARRIED OUT BY A SERVICE AGENT OR A SIMILARLY COMPETENT ELECTRICIAN.
- CAUTION: IN ORDER TO AVOID A HAZARD DUE TO INADVERTENT RESETTING OF THE THERMAL CUT OUT, THIS APPLIANCE MUST NOT BE SUPPLIED THROUGH AN EXTERNAL SWITCHING DEVICE, SUCH AS A TIMER, OR CONNECTED TO A CIRCUIT THAT IS REGULARLY SWITCHED ON AND OFF BY THE UTILITY
- DO NOT OPERATE THE APPLIANCE IF IT IS DAMAGED.
- REPAIRS OF ELECTRICAL APPLIANCES MUST ONLY BE PERFORMED BY AN ELECTRICAL ENGINEER. SHOULD THE APPLIANCE FAIL TO OPERATE, OR IN CASE OF ANY DAMAGE, PLEASE CONTACT THE RETAILER FROM WHOM THE APPLIANCE WAS PURCHASED.
- **CAUTION:** SOME PARTS OF THIS PRODUCT CAN BECOME VERY HOT AND CAUSE BURNS. PARTICULAR ATTENTION MUST BE GIVEN WHERE CHILDREN AND VULNERABLE PEOPLE ARE PRESENT.
- CHILDREN AGED FROM 3 YEARS AND LESS THAN 8 YEARS SHALL ONLY SWITCH ON/OFF THE APPLIANCE PROVIDED THAT IT HAS BEEN PLACED OR INSTALLED IN ITS INTENDED NORMAL OPERATING POSITION AND THEY HAVE BEEN GIVEN SUPERVISION OR INSTRUCTION CONCERNING USE OF THE APPLIANCE IN A SAFE WAY AND UNDERSTAND THE HAZARDS INVOLVED. CHILDREN AGED FROM 3 YEARS AND LESS THAN 8 YEARS SHALL NOT PLUG IN, REGULATE AND CLEAN THE APPLIANCE OR PERFORM USER MAINTENANCE

IF YOU ARE INSTALLING YOUR APPLIANCE IN TO AN EXISTING CHIMNEY CAVITY

- ENSURE THE FLOOR AREA THE APPLIANCE WILL SIT ON IS FLAT AND FREE FROM LOOSE MATERIAL
- ENSURE THE FLUE OUT FROM THE CHIMNEY CAVITY IS SEALED
- IN ORDER TO INSTALL YOUR APPLIANCE EFFECTIVELY DISCUSS WITH YOUR SELLER THE SURROUND NEEDED TO ENCLOSE YOUR APPLIANCE INTO THE INSTALLATION LOCATION
- TO PROVIDE POWER TO THE APPLIANCE INSTRUCT A QUALIFIES ELECTRICIAN TO INSTALL AND POWER SOCKET INSIDE THE CHIMNEY CAVITY, ENSURING THERE IS AN ISOLATION SWITCH ACCESSIBLE OUTSIDE THE CAVITY

HOW TO USE YOUR APPLIANCE 2. APP CONNECTING INSTRUCTIONS

APP DOWNLOAD

- DOWNLOAD "ilektro" FROM THE APP STORE
- SEARCHING (ilektro fireplace) FROM THE APP STORE
- TURN ON THE BLUETOOTH FROM YOUR MOBILE DEVICE

Note: Make sure your mobile phone is well connected to the nearest 2.4GHz WIFI signal, not the 5GHz signal.

Login

ilektro
by PAUL AGNEW | DESIGNS

username

password

reset password

register

login

instructions

privacy policy

LOG IN

- OPEN THE ilektro APP, WAIT A MOMENT FOR THE ilektro APP TO INITIATE AND THEN IT WILL ASK YOU TO CREATE AN ACCOUNT OR LOG IN TO YOUR EXISTING ACCOUNT.

- REGISTER WITH YOUR EMAIL ID OR MOBILE PHONE NUMBER AS THE USERNAME.
- PUT ANY 6 TO 20 DIGIT NUMBERS AS PASSWORD.
- AGREE TO THE TERMS AND CONDITIONS.
- DURING THE PROCESS YOU MAY BE ASKED TO ALLOW THE APP TO KNOW YOUR LOCATION. THIS IS A REQUIREMENT OF THE DEVICE. THE APP WILL ONLY WORK IF YOU ALLOW THIS. THE APP DOES NOT USE THIS INFORMATION IN ANY WAY.

Register

username please entre username

password please entre password

confirm please confirm password

ok

- YOU CAN ALSO RESET YOUR PASSWORD IN THIS INTERFACE

Reset Password

username please entre username

password please entre password

confirm please confirm password

ok

HOW TO USE YOUR APPLIANCE 2. APP CONNECTING INSTRUCTIONS

CONNECTING

- AIM THE REMOTE CONTROL AT THE FIREPLACE, PRESS AND HOLD THE POWER SWITCH BUTTON FOR 5 SECONDS. THE FIREPLACE WILL DISPLAY "P0".
- FIRST CONNECTION SHOULD TURN ON BLUETOOTH. DO NOT CONNECT THE PHONE TO OTHER BLUETOOTH DEVICES.
- ADD THE DEVICE BY PRESSING THE "+". THEN ENTER THE WIFI PASSWORD FOR CONNECTING (NOTE: THE PHONE CAN ONLY CONNECT TO 2.4GHz WIFI AT THAT TIME)

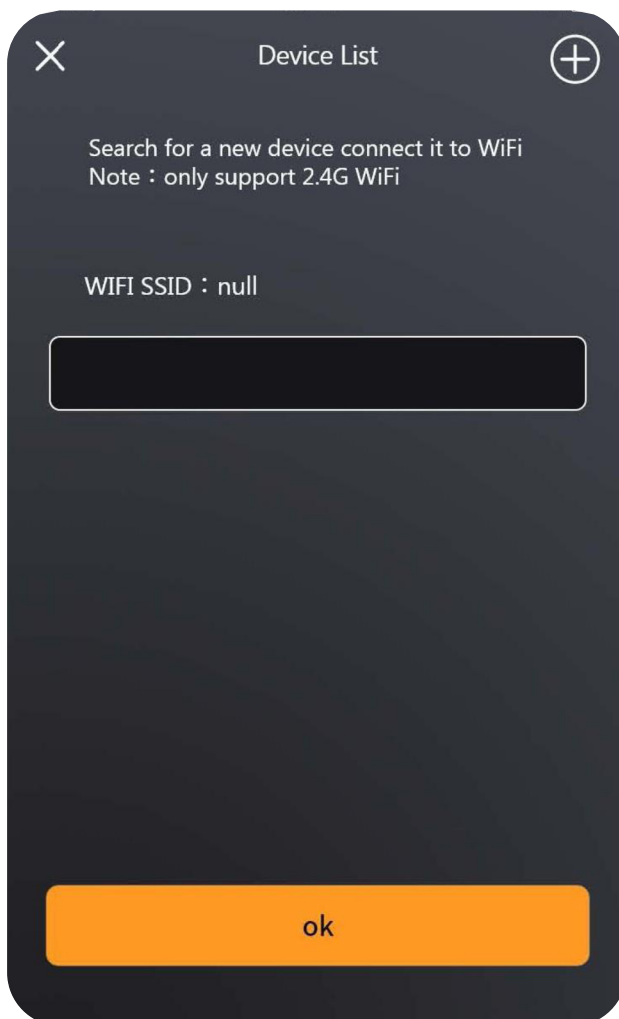

CONNECTING SUCCESSFULLY

THE FIREPLACE WILL DISPLAY "P4" AFTER YOUR FIREPLACE WELL CONNECTED. THE NAME OF THE FIREPLACE APPEARS ON THE PHONE. CLICK THE NAME OF THE ELCTRIC FIREPLACE TO ENTER THE OPERATION INTERFACE.

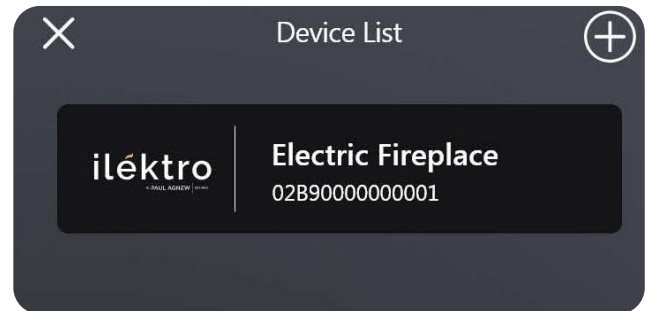

HOW TO USE YOUR APPLIANCE 2. APP CONNECTING INSTRUCTIONS

CONNECTING FAILURE

- PLEASE REPEAT FROM STEP 1 TO STEP 4

FUNCTIONS

LIGHT FUNCTIONS

- YOU CAN CHANGE THE COLOUR AND BRIGHTNESS OF THE FLAME.

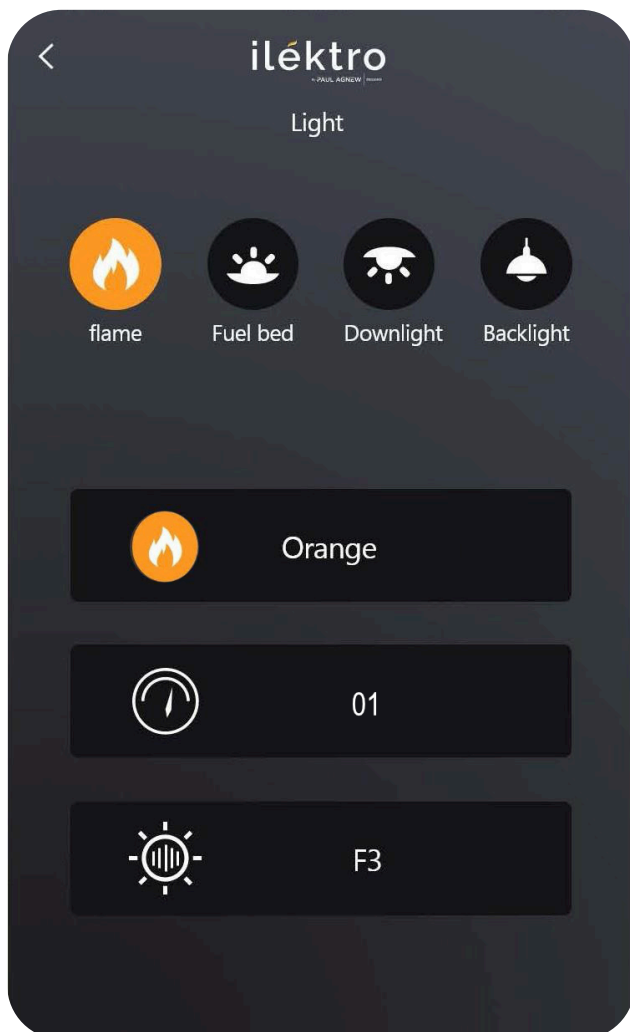

- YOU CAN CHANGE THE COLOUR OF FUEL BED.

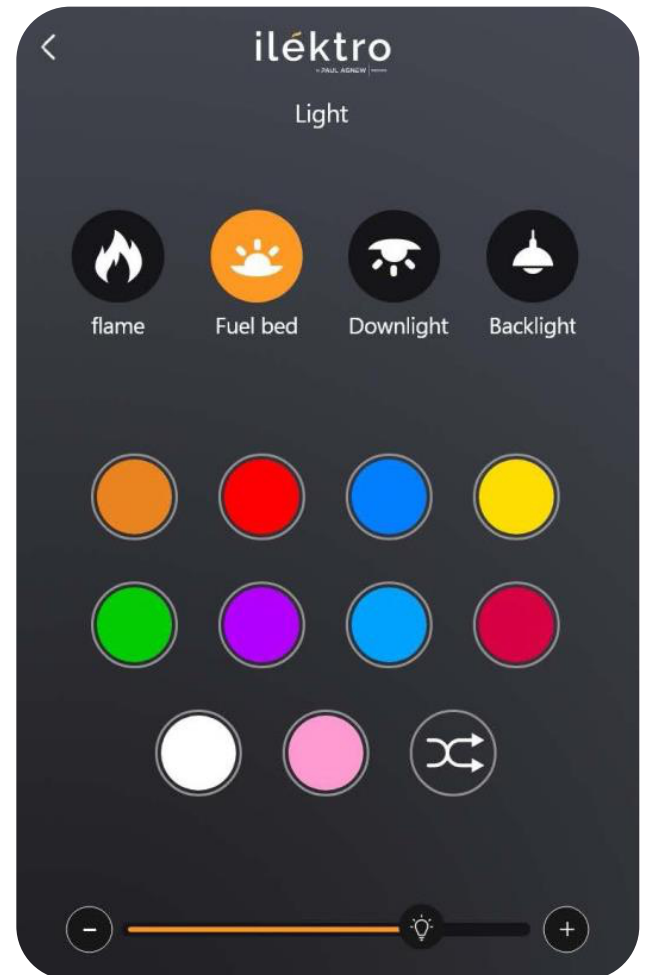

HOW TO USE YOUR APPLIANCE 2. APP CONNECTING INSTRUCTIONS

HEAT FUNCTION

- CHOOSE FOR H1: 1KW OF HEAT OR H2: 2KW OF HEAT (H0: 0KW)



TEMPERATURE FUNCTION

- YOU CAN SET THE TARGET TEMPERATURE; THE FIRE WILL AUTOMATICALLY CONTROL ITS HEATER TO WARM YOUR ROOM TO THAT TEMPERATURE AND MAINTAIN IT AROUND THAT TEMPERATURE.



- ❖ YOUR APP WILL AUTOMATICALLY TAKE THE DAY AND TIME FROM YOUR PHONE OR TABLET. IF YOU ARE SETTING YOUR FIRE UP IN A DIFFERENT TIME ZONE TO THE ONE YOUR PHONE OR TABLET WAS SET UP IN, THEN FIRST SELECT "DATE & TIME" FROM THE SETTINGS MENU AND CHOOSE THE TIME ZONE YOUR FIRE IS LOCATED IN.

NOW SELECT "7-DAY PROGRAMME" FROM THE SETTINGS MENU AND PROCEED AS FOLLOWS:

- TURN ON THE "USE 7-DAY PROGRAMME".
 - SELECT WHETHER YOU WISH TO CONTROL THE FLAME PICTURE ONLY OR THE FLAME PICTURE AND THE HEATING TOGETHER.
 - SELECT THE DAYS YOU WISH TO CONTROL. THERE ARE "BULK" OPTIONS OF "WEEKDAYS", "WEEKENDS" OR "EVERYDAY" OR YOU MAY WISH TO SET EACH DAY SEPARATELY BY SIMPLY SELECTING THE INITIAL LETTER OF THE DAY YOU WISH TO SET.
 - NOW SET THE TIMES AT WHICH YOU WOULD LIKE YOUR FIRE TO OPERATE. ON/OFF FOR "PERIOD 1" BY TOUCHING THE "TIME ON" AND "TIME OFF" BOXES IN TURN.
 - SET THE TARGET TEMPERATURE YOU WOULD LIKE YOUR FIRE TO HEAT THE ROOM TO. THIS OPTION WILL NOT APPEAR IF YOU HAVE ELECTED TO CONTROL THE FLAME PICTURE ONLY AT B ABOVE.
 - IF YOU WOULD LIKE TO CONTROL YOUR FIRE FOR A SECOND PERIOD ON THE SAME DAY(S) THEN FOLLOW THE SAME PROCESS FOR "PERIOD 2".
 - IT IS ESSENTIAL TO TOUCH THE "CONFIRM" BUTTON AT THE BOTTOM OF THIS SCREEN TO SET THE PROGRAMME.**
- ❖ YOU WILL NOTICE THAT ANY SCREEN YOU NAVIGATE TO ONCE YOU HAVE SET THE 7-DAY PROGRAMMER WILL HAVE THE ILLUMINATED CALENDAR ICON AT THE TOP RIGHT-HAND SIDE OF EACH SCREEN. THIS IS A QUICK REFERENCE FOR YOU TO CHECK IF YOUR FIRE HAS THE 7-DAY PROGRAMME SET OR NOT. YOU CAN TOUCH THE CALENDAR ICON TO NAVIGATE QUICKLY TO THE 7-DAY TIMER SCREEN.
 - ❖ TO CANCEL THE 7-DAY PROGRAMMER, TURN OFF THE "USE 7-DAY PROGRAMME" SWITCH AND PRESS THE "CONFIRM" BUTTON. YOUR PREVIOUS SETTINGS WILL BE RETAINED IN CASE YOU WOULD LIKE TO TURN THE 7-DAY PROGRAMMER BACK ON AT SOME FUTURE STAGE.
 - ❖ TO REVIEW YOUR SETTINGS, RETURN TO THE 7-DAY PROGRAMME SCREEN AND TOUCH EACH DAY IN TURN AND REVIEW THE SETTINGS FOR EACH DAY ONE-AT-A-TIME. YOU MAY REVIEW ONE DAY'S SETTING AT TIME ALLOWING YOU TO MAKE FINE ADJUSTMENTS TO EACH DAY AS YOU REQUIRE.
 - ❖ IF YOU DO MAKE ADJUSTMENTS, PLEASE ENSURE THAT YOU "CONFIRM" YOUR NEW SETTINGS BEFORE EXITING THIS SCREEN.

STEP: 01

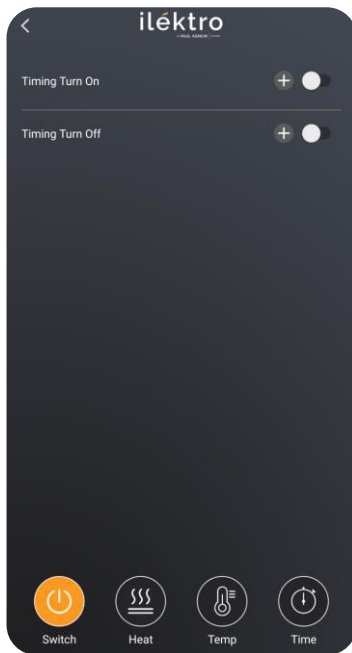

STEP: 02

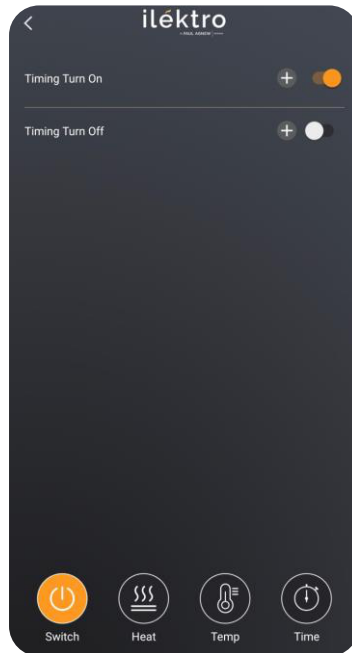

STEP: 03

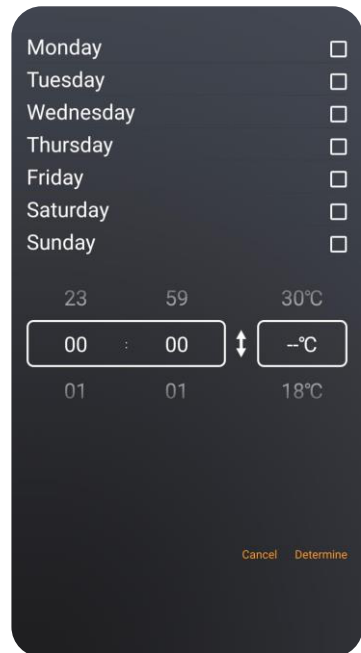

STEP: 04

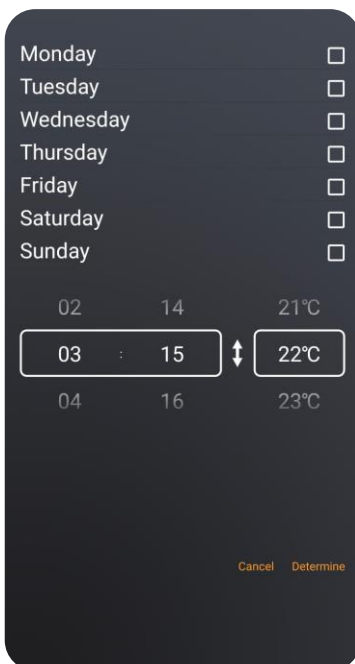

STEP: 05

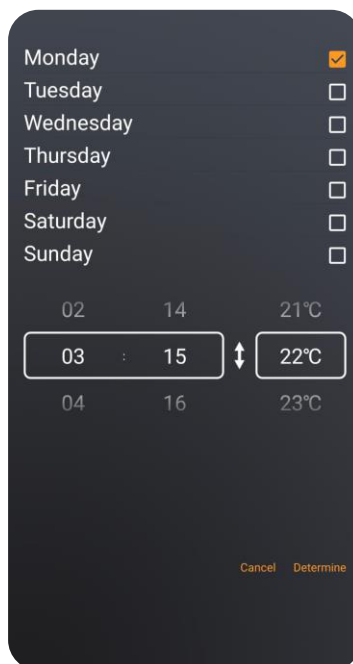

STEP: 06

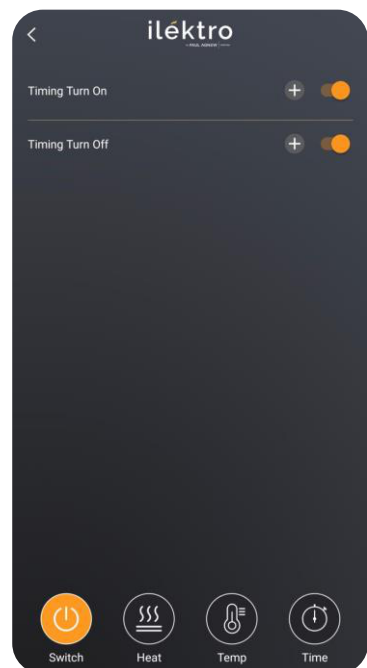

STEP: 07

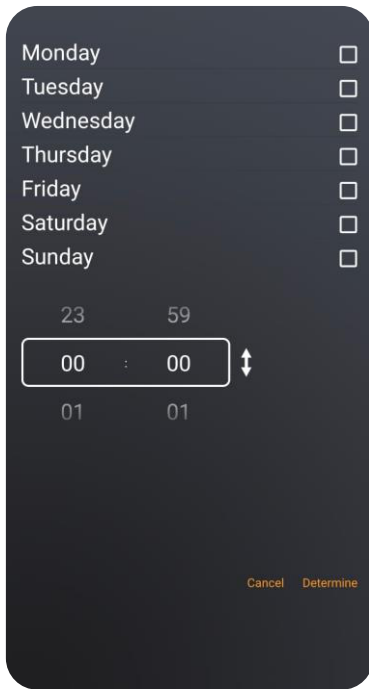

STEP: 08

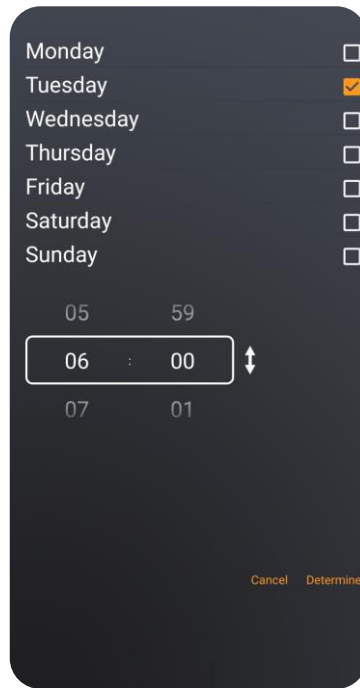

STEP: 09

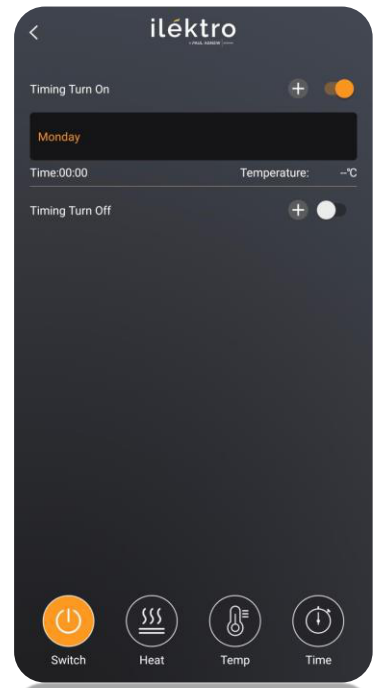

HOW TO USE YOUR APPLIANCE
3. REMOTE CONTROL BUTTONS
AND DISPLAY

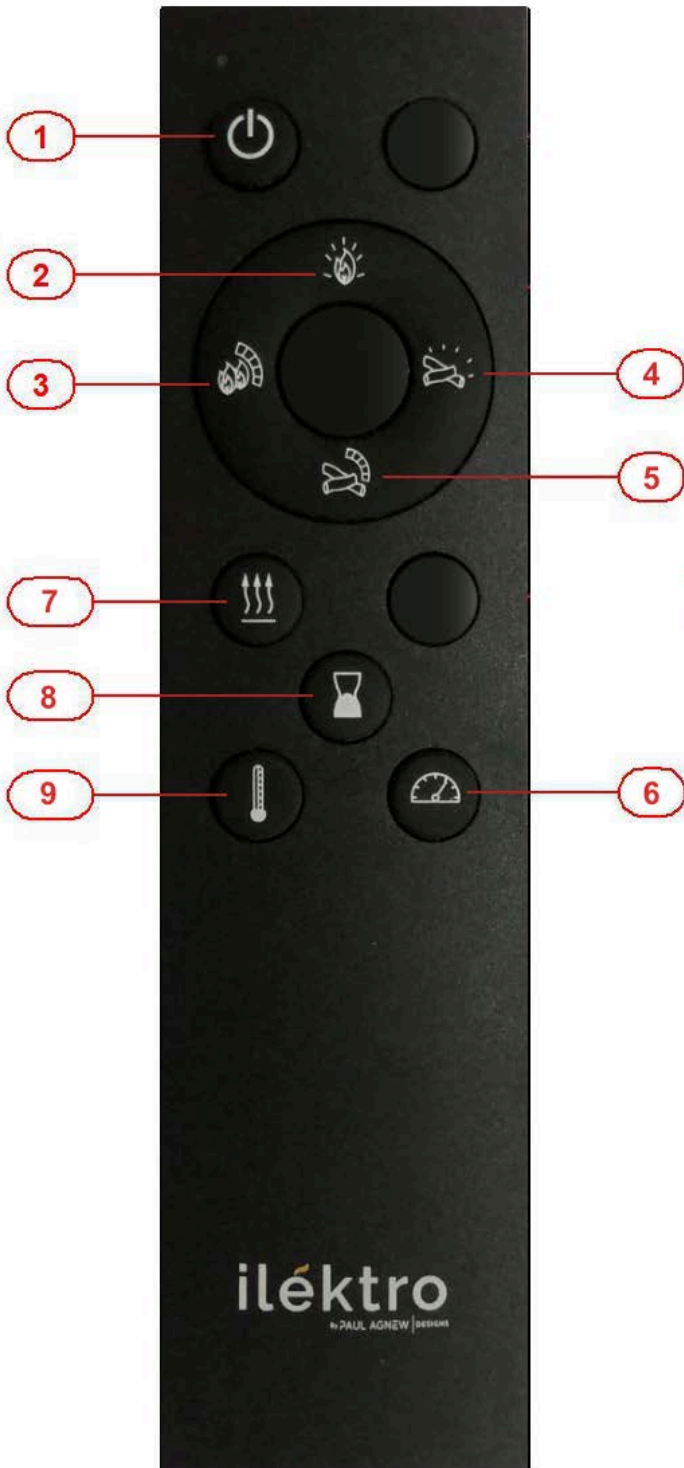

FIG:1 REMOTE CONTROL

1. POWER SWITCH

ON/OFF THE POWER

2. FLAME BRIGHTNESS

FIVE FLAME BRIGHTNESS SETTINGS: F5-F4-F3-F2-F1

3. COLOUR OF FLAME

ORANGE, YELLOW, BLUE, ORANGE-YELLOW, YELLOW-BLUE AND YELLOW-ORANGE-BLUE

4. BRIGHTNESS OF FUEL BED

FIVE FUEL BED BRIGHTNESS SETTINGS: F5-F4-F3-F2-F1, F5 IS THE BRIGHTEST, F1 TURN ON THE PULSATING FUNCTION

5. FUEL BED COLOUR

TEN COLOURS OF FUEL BED SETTINGS: 01 ORANGE, 02 RED, 03 BLUE, 04 YELLOW, 05 GREEN, 06 PURPLE, 07 SKY BLUE, 08 CARMINE, 09 WHITE, 10 PINK, 11 ALL COLOUR CYCLE

6. SPEED OF FLAME

3 FLAME SPEED SETTINGS: 1 LOW SPEED, 2 INTERMEDIATE SPEED, 3 HIGH SPEED

7. HEATING

H0 HEATING OFF, H1 LOW HEATING, H2 HEATING HIGH.

INHIBITION OF HEAT FUNCTION: LONG PRESS THE HEATING BUTTON FOR 5 SECONDS, DISPLAY L0, THE PRODUCT CANNOT BE HEATED AT THIS TIME, HEATING AND TEMPERATURE SETTINGS ARE INVALID, LONG PRESS THE HOT KEY FOR 5 SECONDS OR TURN OFF THE POWER TO TURN OFF AND REMOVE THE INHIBITION OF HEAT FUNCTION.

8. TIMING

POWER PFF FOR 30 MINUTES TO 8 HOURS

30-1H-2H-3H-4H-5H-6H-7H-8H-00

00 IS A TIMED SHUTDOWN

9. TEMPERATURE SETTINGS

18 °, 19 °, 20 °, 21 °, 22 °, 23 °, 24 °, 25 °, 26 °, 27 °, 28 °, 29 °, 30 °, C. C IS SET FOR THE SHUTDOWN TEMPERATURE.

HOW TO USE YOUR APPLIANCE

4. OPERATING INSTRUCTIONS

THERMAL SAFETY CUT OUT

IF THE SAFETY CUT OUT FOR THE HEATER TRIPS THE APPLIANCE HAS OVERHEATED.

IF THIS HAPPENS:

- SWITCH OFF THE DEVICE FROM THE ISOLATION SWITCH AND ALLOW IT TO COOL DOWN FOR A MINIMUM OF 2 HOURS
- CHECK THE HEATER OUTLET VENTS FOR ANY OBSTRUCTION AND CLEAR IF NECESSARY. SEE MAINTENANCE SECTION FOR GUIDANCE
- PLUG IN THE APPLIANCE AND SWITCH IT ON. THE CUT OUT WILL RESET AND THE APPLIANCE SHOULD FUNCTION NORMALLY.
- IF THE APPLIANCE CONTINUES TO NOT FUNCTION CORRECTLY, CONTACT THE RETAILER OR PLACE OF PURCHASE.

HOW TO USE YOUR APPLIANCE

4. MAINTENANCE AND CARE

THE AIR INLET GRILLES ON THE TOPSIDE AND BACK OF THE APPLIANCE SHOULD BE UNOBSTRUCTED. FREE AIR NEEDS TO CIRCULATE IN THIS AREA.

ALWAYS SWITCH OFF THE APPLIANCE FROM THE ISOLATION SWITCH BEFORE CLEANING OR UNDERTAKING AND MAINTENANCE.

GENERAL CLEANING

- ONLY CLEAN THE GLASS WHEN ITS COLD
- DO NOT USE ABRASIVE CLEANERS ON ANY PART OF THE APPLIANCE
- USE A LINT FREE CLOTH TO WIPE ANY SURFACES
- DO NOT SPRAY CLEANER INTO THE APPLIANCE

CLEANING THE FUEL BED

TO ACCESS THE FUEL EFFECT IT WILL BE NECESSARY TO REMOVE THE FRONT GLASS VIEWING PANEL, SEE SERVICING SECTION

- ENSURE THE APPLIANCE IS SWITCHED OFF AT ISOLATION SWITCH.
- REMOVE THE LOGS AND DUST CLEAN. DO NOT WET THE LOGS.
- USE A LINT FREE DUSTER.
- LIFT ALL FUEL MEDIUM OUT OF THE FIRE AND WIPE FUEL BED DOWN.
- ENSURE NO MOISTURE REMAINS BEFORE RETURNING THE LOGS INTO POSITION. SEE LOG INSTALLATION PROCESS.
- CAUTION: REPLACE FRONT TRIM WHILE REMOVING LOGS AND FUEL MATERIAL TO ENSURE PIECES DO NOT FALL INTO THE APPLIANCE
- REPLACE THE GLASS AND TRIM AS DESCRIBED IN THE SERVICING INSTRUCTION SECTION.

HOW TO USE YOUR APPLIANCE
5. MAINTENANCE AND CARE

CLEANING THE OUTLETS

- ENSURE THE APPLIANCE IS SWITCHED OFF AT THE ISOLATION SWITCH
- CLEAN THE AIR OUTLET GRILLES REGULARLY WITH A SOFT CLOTH OR THE NOZZLE OF A VACUUM CLEANER

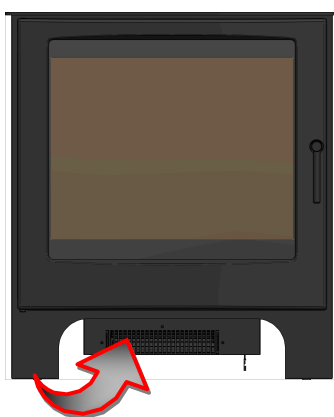

FIG:2 OUTLET

- DUST BUILD-UP CAN INHIBIT EFFICIENT PERFORMANCE OF THE FAN AND LEAD TO THE SAFETY CUT-OUT OPERATING.
- KEEP THE AREA AROUND THE APPLIANCE CLEAN AND FREE OF FLUFF, DUST OR PET HAIR.
- IN PARTICULAR, BUILD-UP OF DUST ETC. CAN OCCUR AROUND THE HEATER VENT AREA. TAKE PARTICULAR CARE TO KEEP THIS AREA FREE FROM SUCH PARTICLES ON A REGULAR BASIS TO PREVENT BUILD-UP.

BATTERY REPLACEMENT

WHEN THE REMOTE BATTERIES IS LOW IT MUST BE CHANGED IMMEDIATELY. INSTALL CORRECT REPLACEMENTS AND DISPOSE OF THE OLD BATTERIES CAREFULLY.

BATTERY REPLACEMENT
REMOTE CONTROL

BATTERY INFORMATION - SEE FIG. 3

1. SLIDE OPEN THE BATTERY COVER ON THE BACK OF THE REMOTE CONTROL
2. INSTALL AAA BATTERIES INTO THE REMOTE CONTROL
3. REPLACE THE BATTERY COVER



Fig.3

DISCARD LEAKY BATTERIES

DISPOSE OF BATTERIES IN THE PROPER MANNER ACCORDING TO LOCAL REGULATIONS.

ANY BATTERY MAY LEAK ELECTROLYTE IF MIXED WITH A DIFFERENT BATTERY TYPE, IF INSERTED INCORRECTLY, IF ALL THE BATTERIES ARE NOT REPLACED AT THE SAME TIME, IF DISPOSED OF IN A FIRE, OR IF AN ATTEMPT IS MADE TO CHARGE A BATTERY NOT INTENDED TO BE RECHARGED.

HOW TO INSTALL YOUR
APPLIANCE
6. TECHNICAL SPECIFICATION

MODEL		WOODLAND ELECTRIC STOVE
WEIGHT KG		50
VOLTAGE		220-240V AC ~50-60HZ
BATTERY HANDSET		12V MN 21/23
TRANSMITTER ELECTRICAL POWER CONSUMPTION	FLAME PICTURE ONLY	8W
	HEATING ON	2000 WATT
SUPPLY CORD	UK	BS1363 UK13A
	AUSTRALIAN	AS/NZS3112
	EUROPEAN	VDE 0620

NOTE:

WEIGHTS UNIT ONLY NOT INCLUDING PACKAGING
SUITE APPLIANCE (S) WEIGHTS ARE NOT INCLUDING WOODEN SURROUND

**THIS APPLIANCE MUST BE
EARTHED**

THIS APPLIANCE HAS BEEN CERTIFIED FOR USE IN COUNTRIES OTHER THAN THOSE STATED. TO INSTALL THIS APPLIANCE IN THESE COUNTRIES, IT IS ESSENTIAL TO OBTAIN THE TRANSLATED INSTRUCTIONS AND IN SOME CASES THE APPLIANCE WILL REQUIRE MODIFICATION. CONTACT YOUR RETAILER FOR FURTHER INFORMATION.

FOR PRODUCT DIMENSIONS AND INSTALLATION GUIDES FOR BUILDING YOU APPLIANCE INTO A LOCATION, PLEASE GO TO WEBSITE: PAULAGNEWDESIGNS.COM.AU. TO DOWNLOAD THE SPEC SHEET FOR YOUR APPLIANCE

HOW TO INSTALL YOUR APPLIANCE

7. GENERAL INSTALLATION

NOTE: INSTALLATION SHOULD BE CARRIED OUT BY A TRAINED INSTALLATION TECHNICIAN. **IF THE PRODUCT IS INSTALLED INCORRECTLY YOUR WARRANTY MY BE INVALID.**

IT IS VERY IMPORTANT THAT THE AIR INLET GRILLES ON THE TOPSIDE AND BACK OF THE APPLIANCE ARE UNOBSTRUCTED AND ADEQUATE SPACE IS LEFT TO ALLOW FREE CIRCULATION OF AIR AROUND THIS AREA.

TOOLS REQUIRED

HEX 3 ALLEN KEY REQUIRED UNSCREW THE SCRUB SCREW TO REMOVE THE HANDLE AND TO OPEN THE DOOR

UNPACKING THE FIREPLACE

WARNING! DO NOT USE THIS APPLIANCE IF ANY PART HAS BEEN EXPOSED TO WATER. IMMEDIATELY CALL A QUALIFIED SERVICE TECHNICIAN TO INSPECT AND TO REPLACE ANY PART OF THE ELECTRICAL SYSTEM IF NECESSARY.

- CAREFULLY UNPACK THE APPLIANCE. TAKE CARE NOT TO DAMAGE THE SURFACE OF THE APPLIANCE OR THE INSTALLATION AREA. KEEP PLASTIC WRAPPING AWAY FROM CHILDREN. BE RESPONSIBLE WHEN HANDLING THE PACKING MATERIALS.
- CHECK ALL PARTS AND ACCESSORIES ARE REMOVED BEFORE DISPOSING OF ANY PACKAGING.
- IF NECESSARY, KEEP THE ORIGINAL PACKAGING FOR FUTURE TRANSPORT AND/OR STORAGE.

FITTING THE APPLIANCE

TAKE CARE WHEN LIFTING THE APPLIANCE, OBTAIN ASSISTANCE IF REQUIRED AND ALWAYS FOLLOW SAFE MANUAL HANDLING TECHNIQUES.

WHEN IN DOUBT CONSULT YOUR RETAILER OR SUITABLY QUALIFIED PERSON.

HOW TO INSTALL YOUR APPLIANCE

8. INSTALLATION

POSITIONING YOUR APPLIANCE

- YOUR NEW APPLIANCE MAY BE INSTALLED VIRTUALLY ANYWHERE IN YOUR HOME. HOWEVER, WHEN CHOOSING A LOCATION ENSURE THAT THE GENERAL INSTRUCTIONS ARE FOLLOWED.
 - THE POSITIONING OF THE APPLIANCE SHOULD IDEALLY BE FITTED INTO/ ONTO A FLAT WALL OF BLOCK/BRICK CONSTRUCTION OR AN INTERNAL WOODEN FRAME PLASTER BOARD WALL. NO FIXINGS ARE PROVIDED WITH YOUR APPLIANCE. PLEASE SEEK ADVICE FROM YOUR RETAILER REGARDING FIXING METHODS, BASED ON YOUR CHOSEN INSTALLATION POSITION AND YOUR WALL MATERIAL.
 - ALWAYS ENSURE THE APPLIANCE IS ADEQUATELY SUPPORTED AND SITS ON A FIRM STRUCTURE WHEN MOUNTING ABOVE FLOOR LEVEL.
 - IF THE POWER CORD IS DAMAGED, IT MUST BE REPAIRED BY THE MANUFACTURER, ITS AUTHORIZED SERVICE CENTRE OR PROFESSIONAL PERSON.
 - ENSURE THAT CURTAINS AND FURNITURE ARE NOT POSITIONED CLOSE TO THE CHOSEN POSITION, AS THIS WOULD CREATE A POTENTIAL FIRE HAZARD OR BLOCK THE HEATER OUTLET DUCTS. FOR BEST RESULTS, INSTALL OUT OF DIRECT SUNLIGHT.
- THE APPLIANCE SHOULD IDEALLY BE LOCATED CLOSE TO A SUITABLE MAINS SOCKET TO ENABLE CONNECTION. THE ELECTRICAL SOCKET MUST BE EASILY ACCESSIBLE TO ALLOW DISCONNECTION WHEN THE APPLIANCE IS FITTED.
 - WARNING! IF THE ELECTRICAL SOCKET IS NOT ACCESSIBLE ONCE THE APPLIANCE HAS BEEN INSTALLED THEN A QUALIFIED ELECTRICIAN WILL NEED TO INSTALL AN ISOLATION SWITCH.
 - WARNING! KEEP ANY FURNISHINGS OR COMBUSTIBLE MATERIALS AT LEAST 1m FROM THE FRONT OF THE ELECTRIC FIREPLACE.

9. SETTING THE FUEL BED

- INCLUSIONS:

CERAMIC LOG SETS (8 PIECE LOG SET)
 AMBER CRYSTALS
 BLACK CRYSTALS
 COALS CHIP



FIG 4: LOG SET



FIG 5: CRYTALS AND COAL CHIPS

CAUTION CERAMIC LOG SETS ARE DELICATE. TAKE CARE WHEN HANDLING.

- STEP 1
SPREAD AMBER CRYSTALS ON FUEL BED
- STEP 2
POSITION CERAMIC LOG AS PER THE DIAGRAM AS SHOWN BELOW. RANDOMLY STACK AND OVERLAY LOGS AGAINST EACH OTHER.
- STEP 3
DISTRIBUTE THE BLACK CRYSTALS EVENLY ACROSS THE FUEL BED.
- STEP 4
DISTRIBUTE THE COALS CHIPS EVENLY ACROSS THE FUEL BED.



FIG 6: LOG ARRANGEMENT

HOW TO INSTALL YOUR APPLIANCE

10. ELECTRICAL CONNECTION

WARNING

ENSURE THE APPLIANCE IS FULLY ASSEMBLED AND THE FRONT GLASS WITH TRIM IS BACK IN THE APPLIANCE BEFORE THE APPLIANCE IS CONNECTED TO MAINS POWER

CONNECTING TO MAINS SUPPLY

- CHECK WHETHER THE MAINS SUPPLY CAN ACCOMMODATE THE ADDITIONAL LOAD OF 1000 OR 2000 WATT

- CONNECT THE POWER CABLE TO AN EARTHED SOCKET
- ONLY USE THE POWER CABLE PROVIDED WITH YOUR APPLIANCE AS IT WILL BE CORRECT FOR YOUR REGION

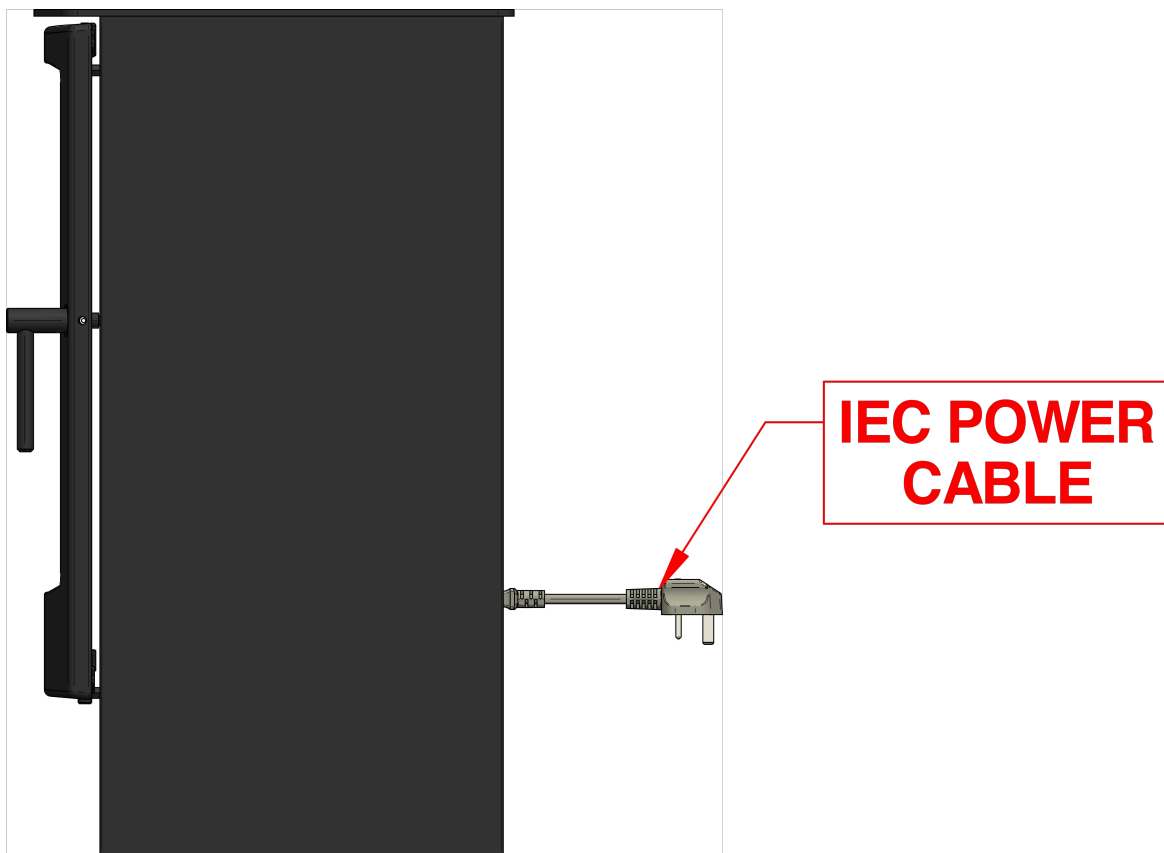

FIG 7: IEC POWER CABLE

SERVICING INSTRUCTIONS

11. GENERAL INFORMATION

THIS APPLIANCE MUST ONLY BE SERVICED BY A SUITABLY QUALIFIED PERSON.

BEFORE UNDERTAKING ANY WORK ON THE APPLIANCE: SWITCH OFF THE APPLIANCE FROM THE ISOLATION SWITCH.

WAIT FOR AT LEAST 10 MINUTES UNTIL THE APPLIANCE HAS COOLED DOWN.

REMOTE HANDSET BATTERY REPLACEMENT THE REMOTE-CONTROL HANDSET, USES 2 X AAA BATTERIES FOR POWER OPERATION, THESE WILL NEED REPLACING OVER A PERIOD OF TIME.

FOR REPLACEMENT:

- OPEN THE BATTERY COMPARTMENT COVER ON THE REAR OF THE HANDSET.
- REMOVE THE OLD BATTERIES AND REPLACE OBSERVING THE CORRECT POLARITY (+ & -) AS MARKED UPON THE BATTERIES AND
- HANDSET REMOTE CONTROL. REPLACE THE HANDSET COVER.

MAINTENANCE OF MOTORS

THE MOTORS USED ON THE FAN AND FLAME EFFECT ARE PRE-LUBRICATED FOR EXTENDED BEARING LIFE AND REQUIRE NO FURTHER LUBRICATION. HOWEVER, PERIODIC CLEANING/ VACUUM OF THE FAN/HEATER UNIT IS RECOMMENDED.

RESETTING THE THERMAL CUT OUT SWITCH

THE APPLIANCE IS FITTED WITH AN ELECTRONIC SAFETY CONTROL (E.S.). THIS IS A SAFETY DEVICE WHICH SWITCHES OFF THE HEAT ONLY IF, THE APPLIANCE OVERHEATS FOR ANY REASON
E.G. WHEN COVERED.

IF THE HEATER STOPS OPERATING WHILST THE FLAME EFFECT CONTINUES NORMALLY, THIS INDICATES THAT THE E.S. CONTROL IS IN OPERATION.

THE E.S. CONTROL CAN ONLY BE RE-SET AFTER THE APPLIANCE HAS COOLED DOWN.

TO RE-SET THE E.S.:

- SWITCH OFF THE APPLIANCE (ISOLATION SWITCH) AND LEAVE FOR UP TO 2 HOURS.
- REMOVE ANY OBSTRUCTION TO THE FAN HEATER OUTLET OR OTHER INTERNAL PARTS.
- SWITCH ON APPLIANCE AND THE E.S. CONTROL WILL RE-SET.
- ENSURE THAT THE APPLIANCE IS FUNCTIONING CORRECTLY. IF THE E.S. CONTROL OPERATES AGAIN, THE APPLIANCE SHOULD BE CHECKED BY A COMPETENT ELECTRICIAN.

IF THE POWER SUPPLY IS INTERRUPTED (POWER FAILURE) OR THE APPLIANCE IS TURNED OFF AT THE ISOLATION SWITCH WHILST THE HEATER IS ON, IT WILL BE NECESSARY TO DISCONNECT THE APPLIANCE FROM THE MAINS SUPPLY AND LEAVE FOR 5 MINUTES IN ORDER TO DISCHARGE THE ELECTRONICS BEFORE ATTEMPTING TO TURN THE APPLIANCE ON.

SERVICING INSTRUCTIONS

12. FAULT FINDING

OPERATE APPLIANCE BEFORE COMMISSIONING

1. CLICK ON THE REMOTE HANDSET POWER BUTTON. IF THE APPLIANCE DOES NOT FUNCTION, THEN, FOLLOW POINTS 1, 2, 3, 4 AND 5 RESPECTIVELY.
2. CHECK THE POWER CONNECTION AT THE ISOLATION SWITCH IS IN THE ON POSITION.
3. CHECK THE ISOLATION SWITCH ON THE APPLIANCE (SEE STICKER ON THE APPLIANCE). THE SWITCH MUST BE SET TO THE "I" POSITION
4. CHECK THE BATTERIES IN YOUR HANDSET. CHECK IF THE BATTERIES ARE IN THE CORRECT POSITION AND REFIT IF NECESSARY.
5. IF AFTER CHECKING 1, 2, 3 & 4 NOTHING STILL HAS HAPPENED, THEN DISCONNECT THE POWER FROM THE MAINS (UNPLUG FROM SOCKET), AND WAIT FOR 60 SECONDS, THEN PLUG IT BACK IN AND REPEAT STEPS 1 TO 4. IF YOU DO NOT HAVE ACCESS TO THE MAINS SWITCH, BECAUSE IT IS BUILT-IN, THEN SWITCH OFF THE UNIT FROM ISOLATION SWITCH.

MANUAL
ON/OFF
SWITCH

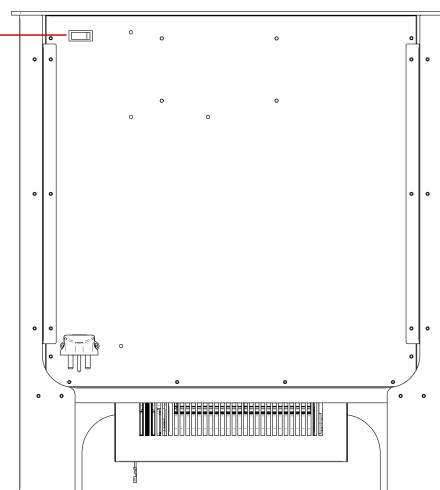

FIG:8 ISOLATION SWITCH

NOTE:

THE UNIT CAN BE OPERATED BY SUPPLIED REMOTE CONTROL ONLY. FOR THE UNIT TO OPERATE, THE MANUAL ON/OFF SWITCH, LOCATED ON THE REAR TOP RIGHTSIDE OF THE FIREPLACE MUST BE SWITCHED TO THE "I" POSITION.

FAULT: THE HEATING DOES NOT TURN-ON WHEN YOU SELECT HEATING MODE BUT THE FLAME EFFECT IS RUNNING.

A) CHECK THE BATTERIES IN YOUR HAND SET. THE RED LED MUST BE SHOWING BRIGHTLY.

B) TRY SELECTING HEATING MODE AGAIN, BUT CLOSER TO THE APPLIANCE.

C). TURN OFF APPLIANCE, THEN TURN IT ON AGAIN. WAIT FOR 10 SECONDS, THEN SELECT HEATING MODE AGAIN.

REFERENCE INFORMATION
13. WIRING DIAGRAM

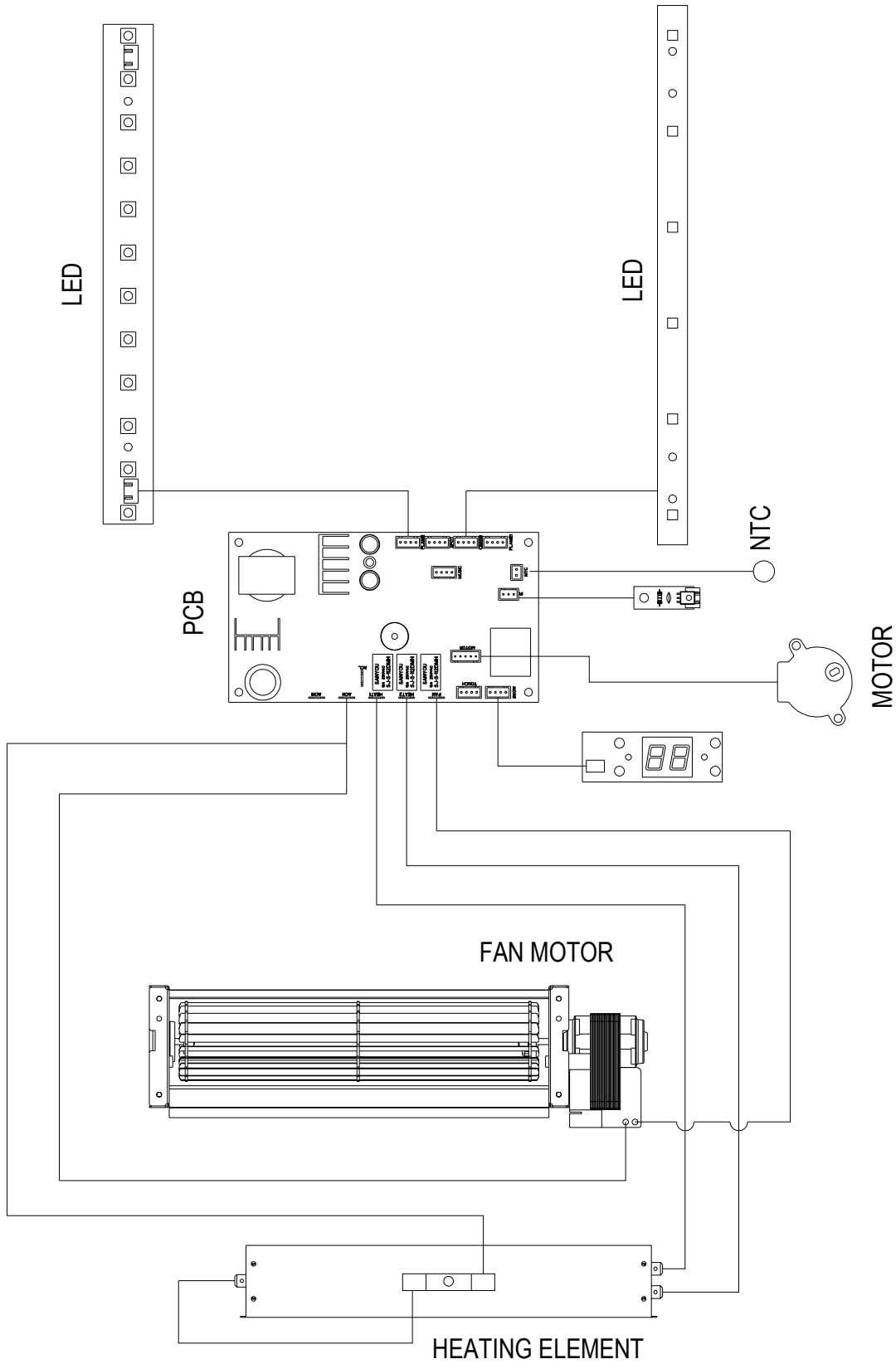

FIG 9: WIRING DIAGRAM

REFERENCE INFORMATION
14. EXPLODED DIAGRAM

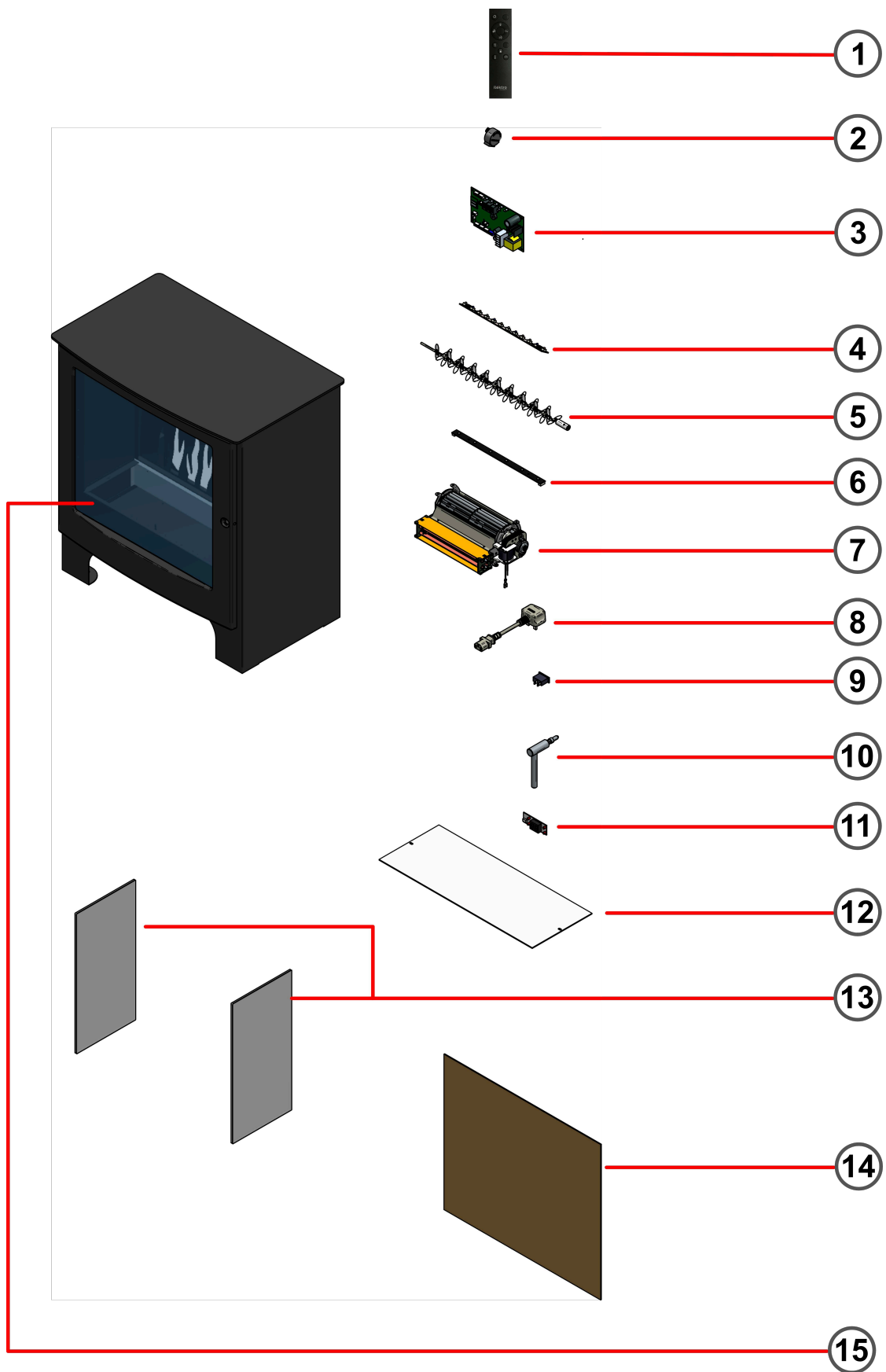

FIG 10: EXPLODED DIAGRAM

REFERENCE INFORMATION
13. EXPLODED DIAGRAM

Replaceable Parts

No	Description	Part Number
1	REMOTE CONTROL	WOODLAND STOVE REMOTE
2	SYNCHRONOUS MOTOR	430000210000
3	MAIN PCB BOARD	440402830125
4	FUEL BED LED	440402810100
5	FLAME EFFECT ROTTISORIE	510400300430
6	FLAME LED	440402820100
7	FAN AND HEATING ELEMENT	430400030150
8	IEC CABLE	470000070300
9	ISOLATION SWITCH	460000010400
10	HANDLE SS	EL-800-308-0
11	DISPLAY BOARD	440402830001
12	FUEL BED	300400233610
13	SIDE GLASS	500400077800
14	SCREEN BOARD	300401300700
15	FRONT GLASS	500400077700

**Technical support
UK Distributor**

Eurostove Ltd

**Unit H1
Mendip Industrial Estate
Rooksbridge
Somerset
BS26 2UG**

Tel: +44(0)1934 750500

Fax: +44(0)1173 156207

technical@eurostove.co.uk

www.eurostove.co.uk

iléktró